

Contents

Item No.	Specifications	Selection Chart	Performance Curve	Pump Dimensions	Sectional View
3U-32-125-3HP	402	403	404	426	430
3U-32-160A-5HP					
3U-32-160B-5HP					
3U-32-200-7½HP			405		
3U-32-200-1-10HP					
3U-40-125A-5HP			406		
3U-40-125B-5HP			407		
3U-40-160-7½HP					
3U-40-160-1-10HP					
3U-40-200A-15HP			408		
3U-40-200B-15HP			409		
3U-50-125-7½HP					
3U-50-125-1-10HP					
3U-50-160-10HP			410		
3U-50-160-1-15HP			411		
3UB 65-125-7.5	402	403	412	428	430
3UB 65-125-10			413		
3UB 65-160-10			414		
3UB 65-160-15			415		
3UB 65-160-20			416		
3UB 65-160-25			417	429	431
3UB 65-200-20			418		
3UB 65-200-25			419		
3UB 65-200-30			420		

Model 3U - 1725RPM

Item No.	Selection Chart	Performance Curve
3U4 32-200-1HP	421	422
3U4 32-200-1-1½HP		
3U4 40-160-1HP		423
3U4 40-200A-1½HP		
3U4 40-200B-2HP		424
3U4 50-125-1HP		
3U4 50-160-1½HP		425
3U4 50-160-1-2HP		



Model 3U/3UB

EBARA Stainless Steel Centrifugal Pumps

Model Designation

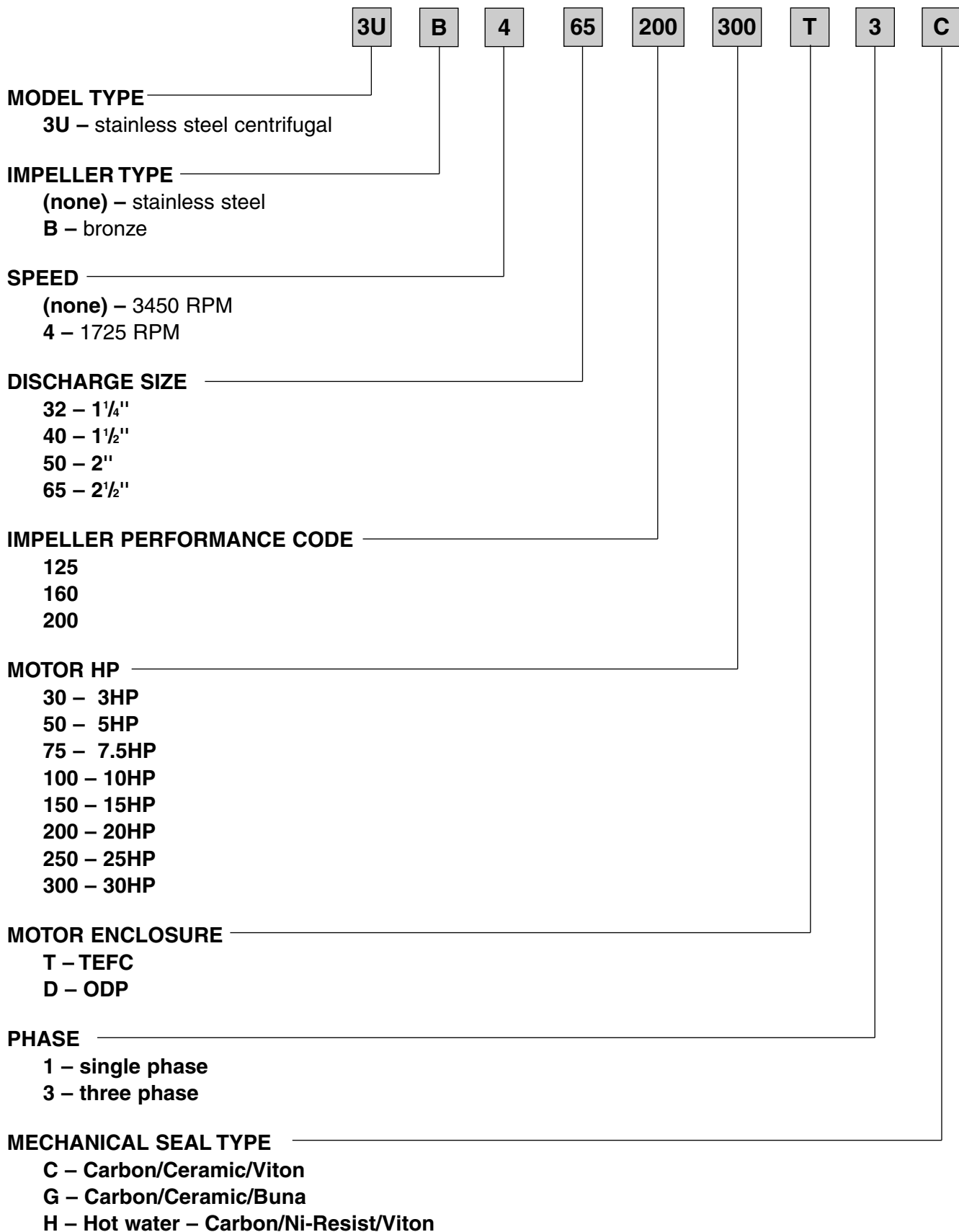

Specifications

	Standard	Optional										
Size Suction (150 lb. ANSI R.F. equivalent) Discharge (150 lb. ANSI R.F. equivalent)	3U32 – 2" ANSI Equivalent 3U40 – 2½" ANSI Equivalent 3U50 – 2½" ANSI Equivalent 3UB65 – 3" ANSI Equivalent 3U32 – 1¼" ANSI Equivalent 3U40 – 1½" ANSI Equivalent 3U50 – 2" ANSI Equivalent 3UB65 – 2½" ANSI Equivalent	Companion Flange kit 150 Lb. ANSI, Female NPT										
Range of HP	3U – 3 HP to 15 HP 3UB – 7½ HP to 30 HP											
Range of Performance Capacity Head	13 to 650 GPM at 3450 RPM 33 to 250 feet at 3450 RPM											
Liquid handled Type of liquid Temperature Max. working pressure	Clean water 212°F (100°C) 230 PSI (15 Bar)	Max. 250°F (121°C) with optional high temperature seal										
Materials Casing Impeller (closed type) Shaft Sleeve Bracket	<table border="0"> <tr> <td>3U</td> <td>3UB</td> </tr> <tr> <td>304L Stainless Steel</td> <td>304L Stainless Steel</td> </tr> <tr> <td>304L Stainless Steel</td> <td>Bronze</td> </tr> <tr> <td>304L Stainless Steel</td> <td>304L Stainless Steel</td> </tr> <tr> <td>Cast iron</td> <td>Cast iron</td> </tr> </table>	3U	3UB	304L Stainless Steel	304L Stainless Steel	304L Stainless Steel	Bronze	304L Stainless Steel	304L Stainless Steel	Cast iron	Cast iron	3UB – Optional stainless steel impeller
3U	3UB											
304L Stainless Steel	304L Stainless Steel											
304L Stainless Steel	Bronze											
304L Stainless Steel	304L Stainless Steel											
Cast iron	Cast iron											
Shaft Seal Seal Material	Mechanical Seal – Type 21 Carbon/Ceramic/Viton Carbon/Ceramic/Buna Hot water – Carbon/Ni-Resist/Viton, 250°F (121°C) max.	Consult factory for additional optional seal availability										
Direction of Rotation	Clockwise when viewed from motor end											
Motor Type Speed Bearing Single Phase Three Phase Motor Protection	NEMA JM, TC, TSC Frame 60 Hz, 3450 RPM (2 poles) Ball Bearing TEFC – 3 HP ODP – 3 HP to 10 HP TEFC – 3 HP to 30 HP ODP – 3 HP to 30 HP 208-230/460V Overload protection must be provided	4 pole – consult factory as noted Explosion proof – consult factory for availability Washdown duty – consult factory for availability										
Standard Accessories	Suction and Discharge Flange Gasket Motor support											



Synchronous Speed 3450 RPM

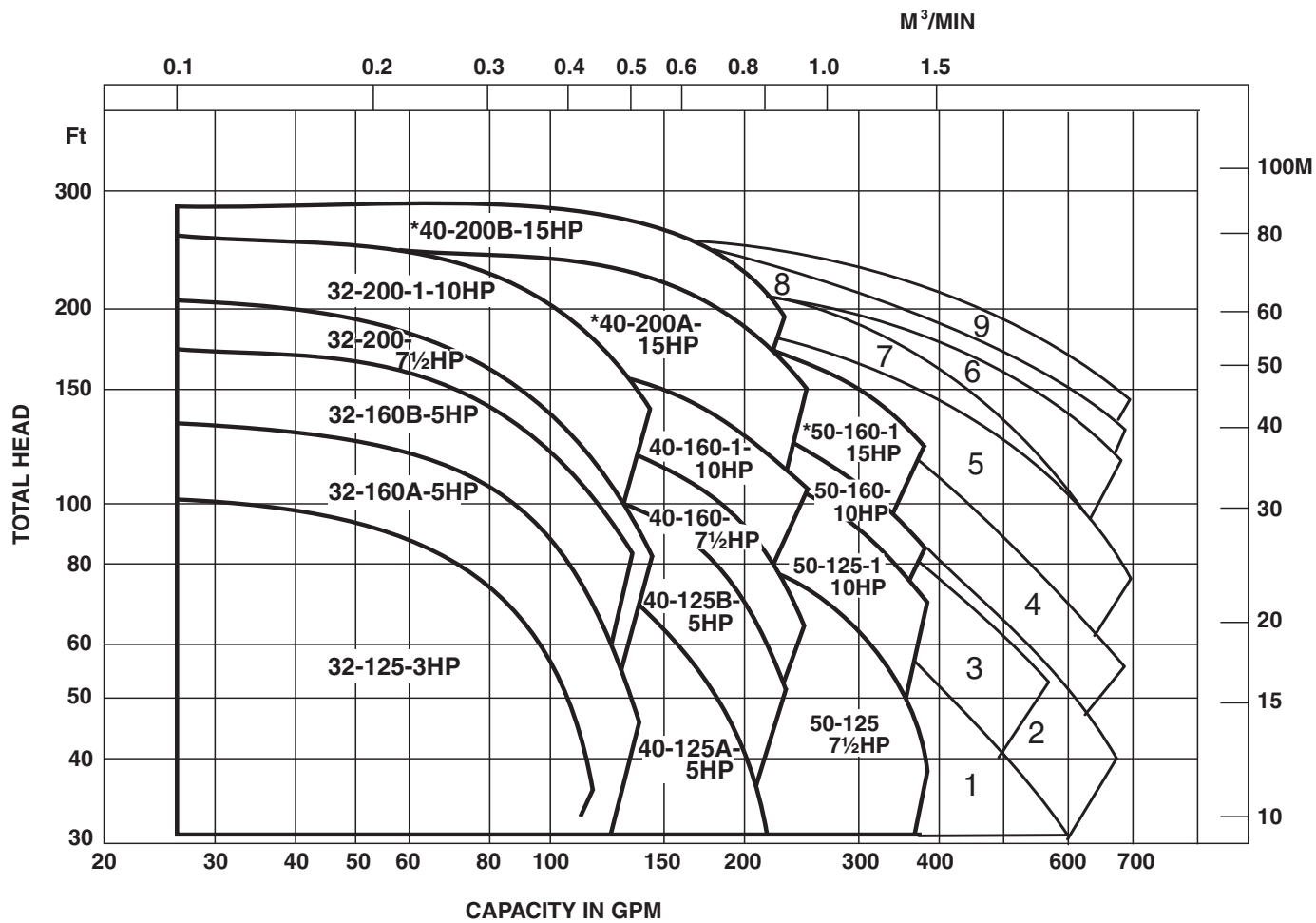

*Three phase motor only

1. 3U65-125-7.5HP
2. 3U65-125-10HP
3. 3U65-160-10HP
4. 3U65-160-15HP*
5. 3U65-160-20HP*
6. 3U65-160-25HP*
7. 3U65-200-20HP*
8. 3U65-200-25HP*
9. 3U65-200-30HP*

Model 3U

EBARA Stainless Steel Centrifugal Pumps

Performance Curves

3U 32-125-3HP

Synchronous Speed: 3450 RPM

Size: 1 1/4 x 2 x 5 3/16

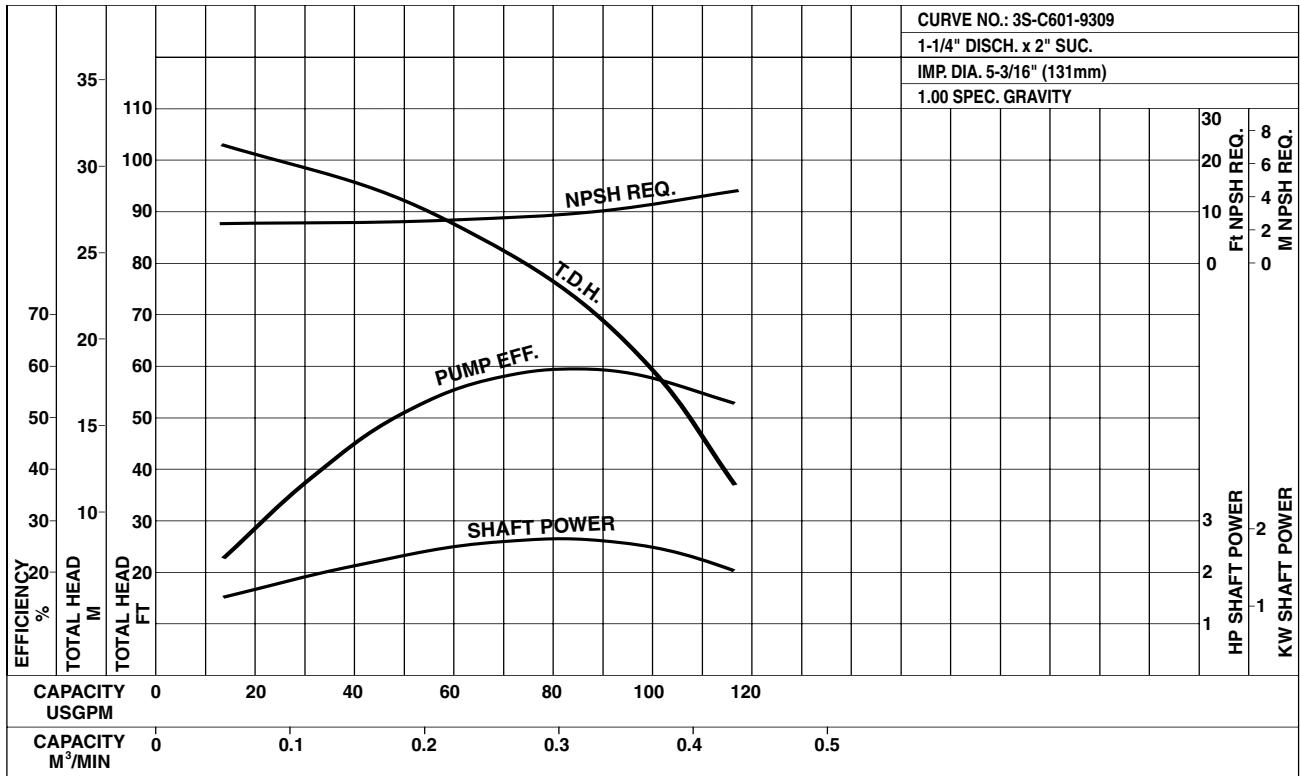

3U 32-160A-5HP

Synchronous Speed: 3450 RPM

Size: 1 1/4 x 2 x 5 15/16

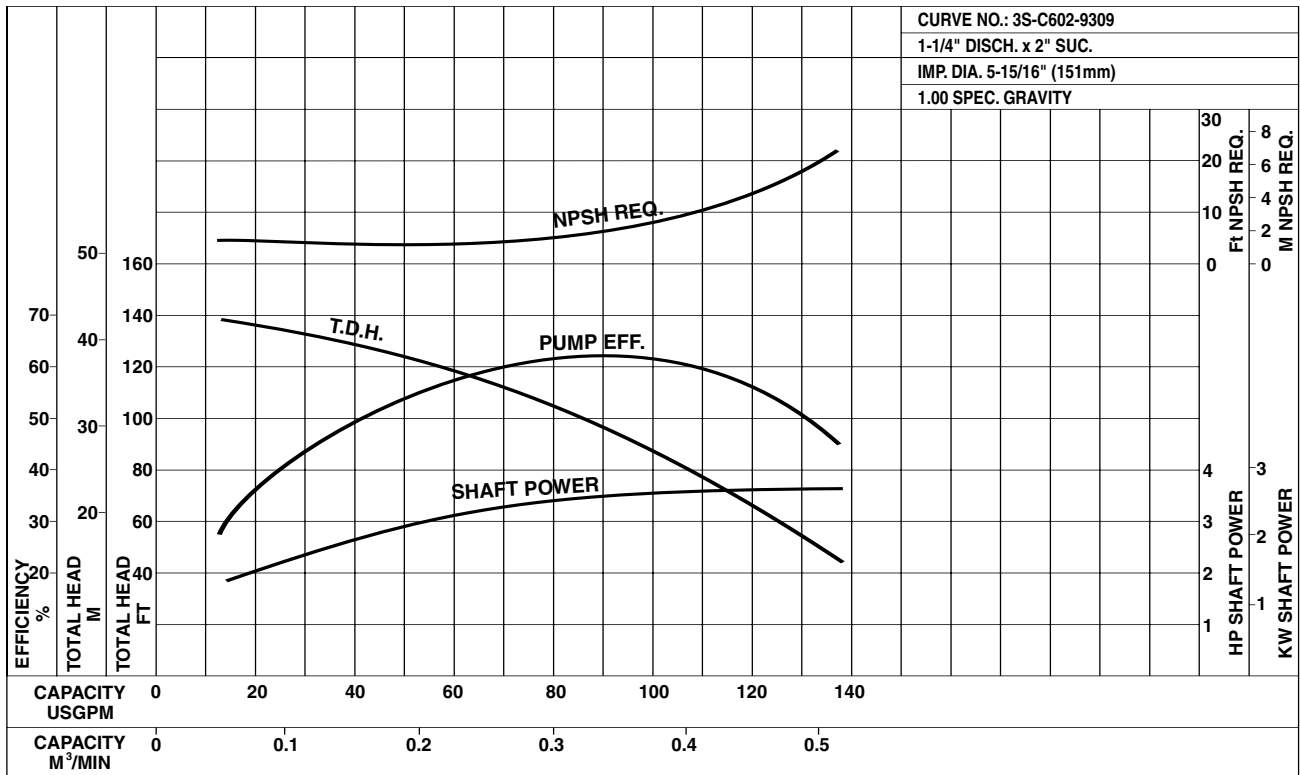

Model 3U

EBARA Stainless Steel Centrifugal Pumps

Performance Curves

3U 32-160B-5HP

Synchronous Speed: 3450 RPM

Size: 1 1/4 x 2 x 6 9/16

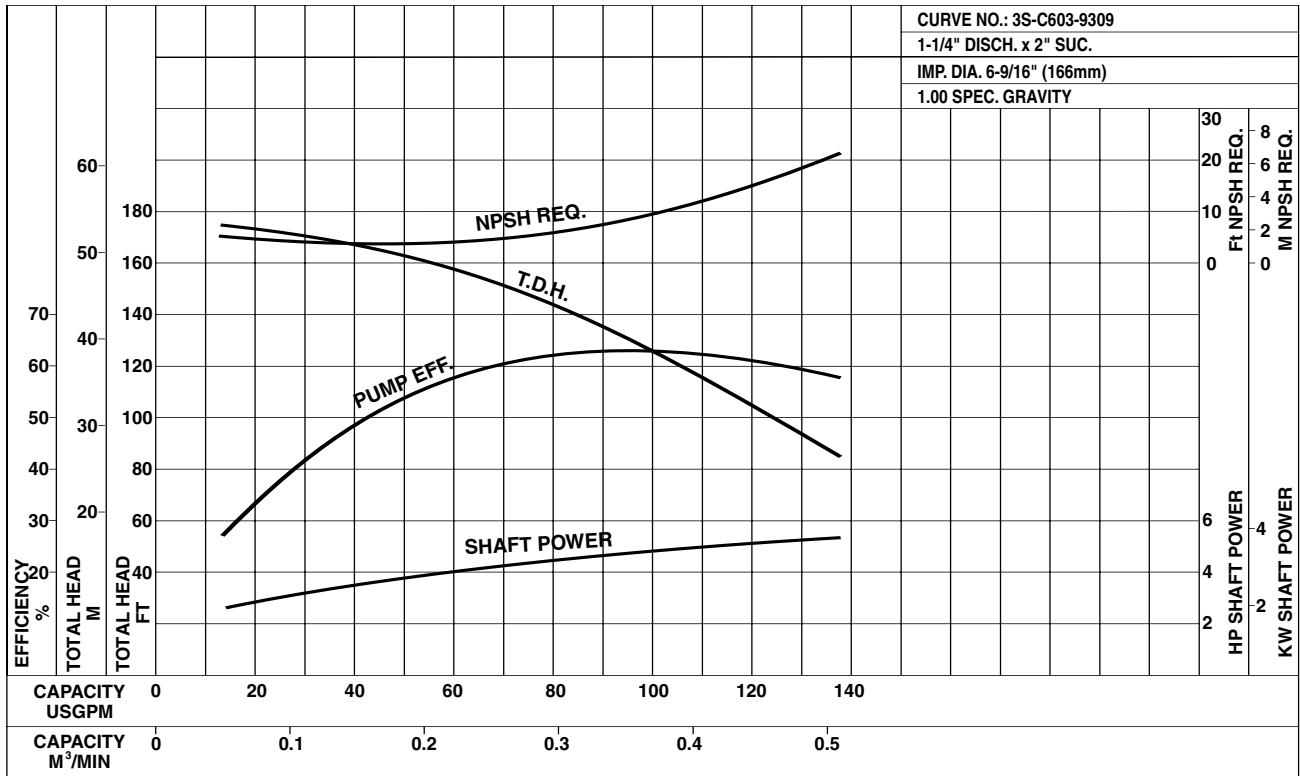

3U 32-200-7 1/2 HP

Synchronous Speed: 3450 RPM

Size: 1 1/4 x 2 x 7 5/16

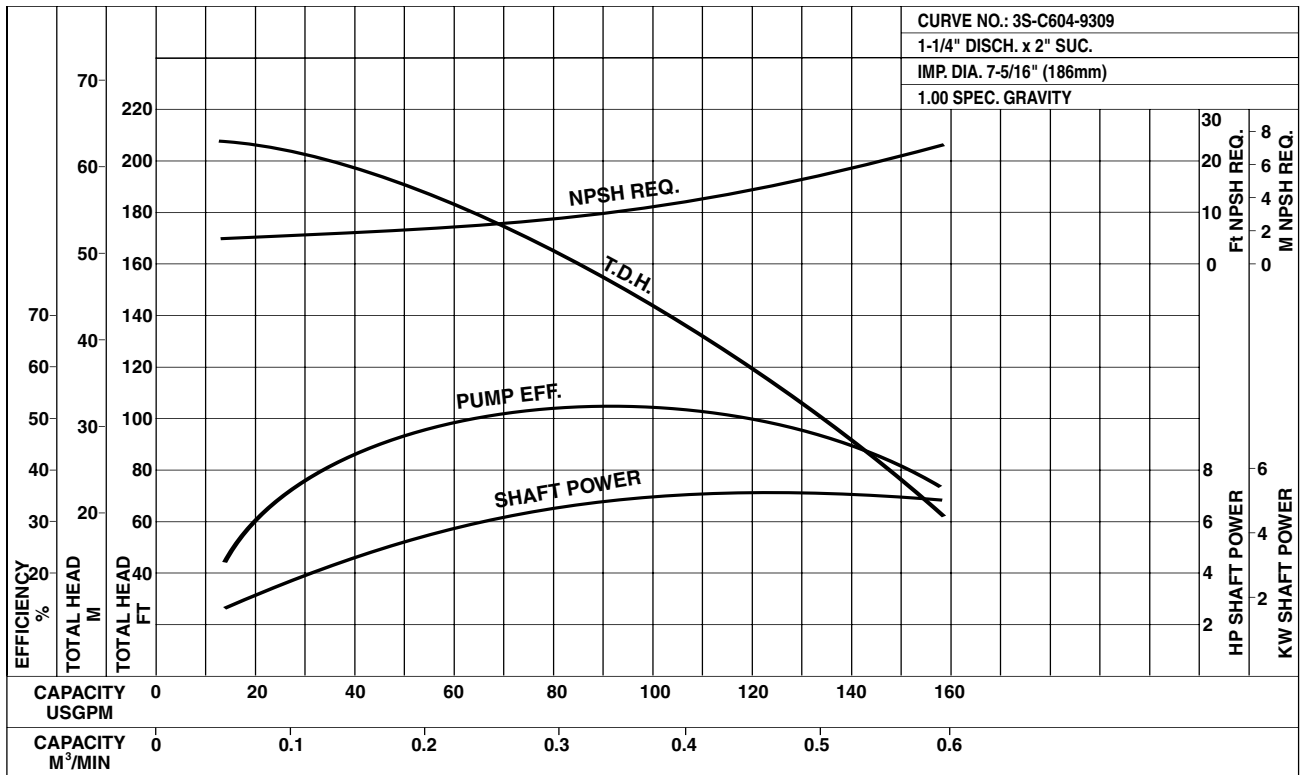

Model 3U

EBARA Stainless Steel Centrifugal Pumps

Performance Curves

3U 32-200-1-10HP

Synchronous Speed: 3450 RPM

Size: 1 1/4 x 2 x 7/8

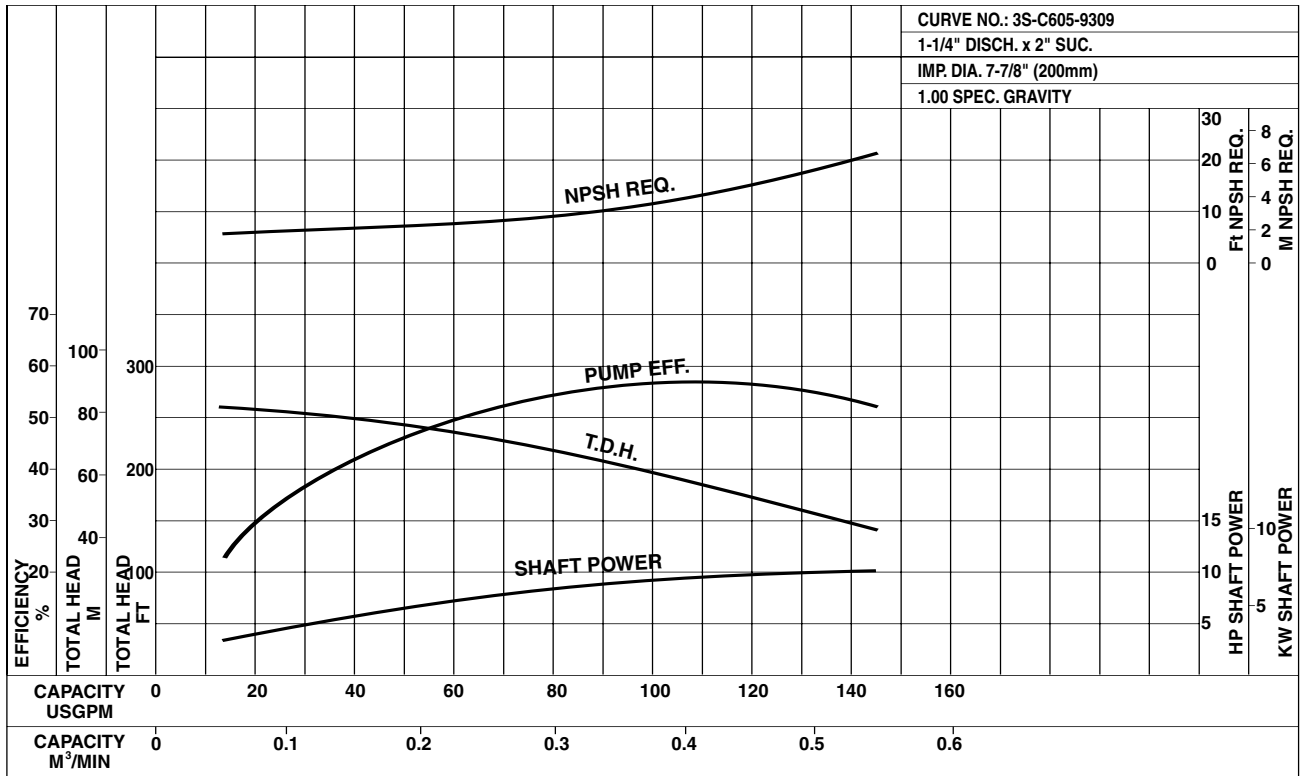

3U 40-125A-5HP

Synchronous Speed: 3450 RPM

Size: 1 1/2 x 2 1/2 x 4 15/16

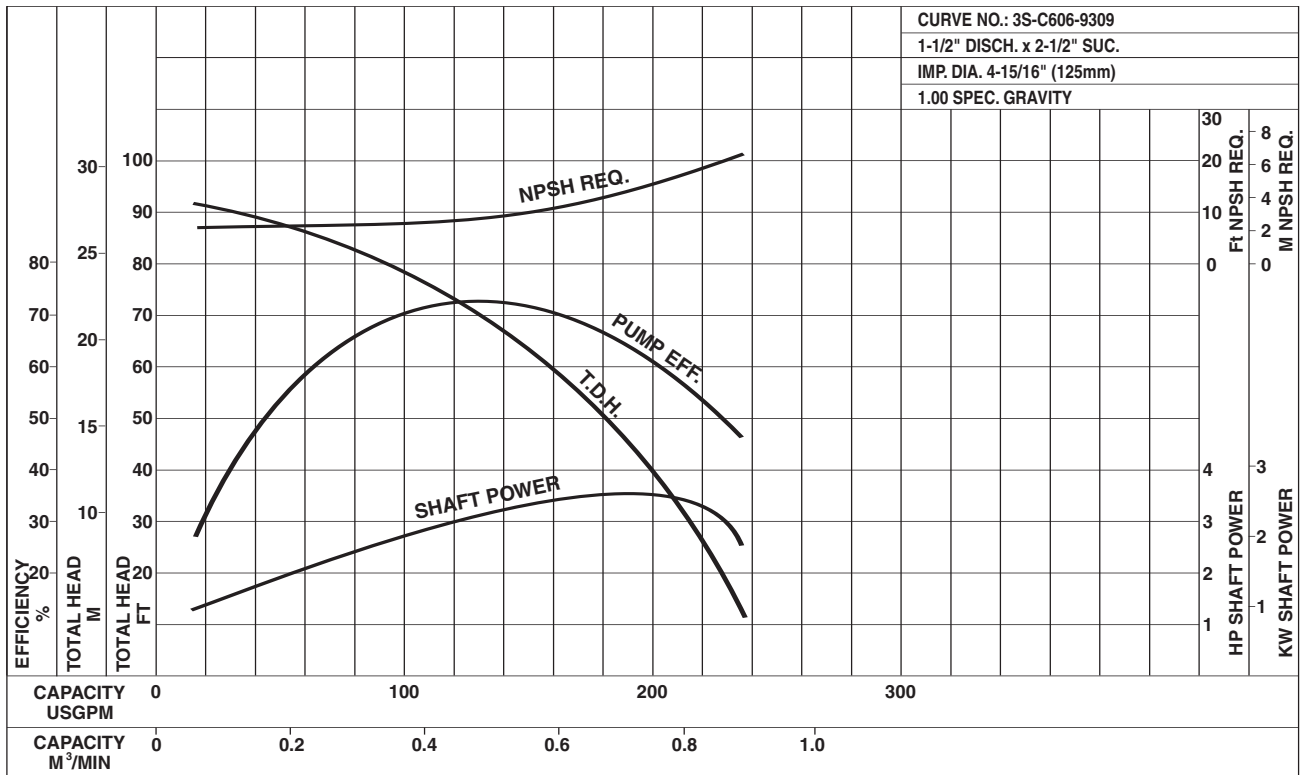

Model 3U

EBARA Stainless Steel Centrifugal Pumps

Performance Curves

3U 40-125B-5HP

Synchronous Speed: 3450 RPM

Size: 1 1/2 x 2 1/2 x 5 1/2

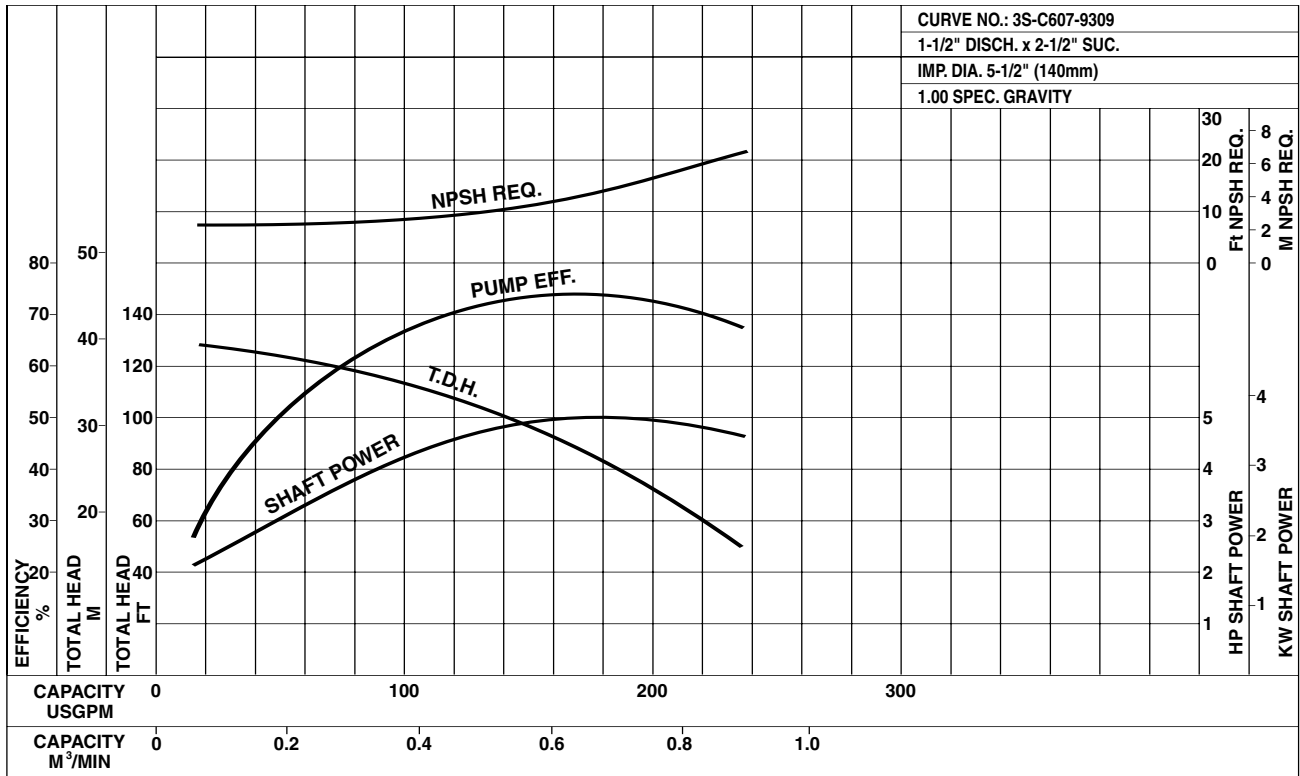

3U 40-160-7 1/2 HP

Synchronous Speed: 3450 RPM

Size: 1 1/2 x 2 1/2 x 5 15/16

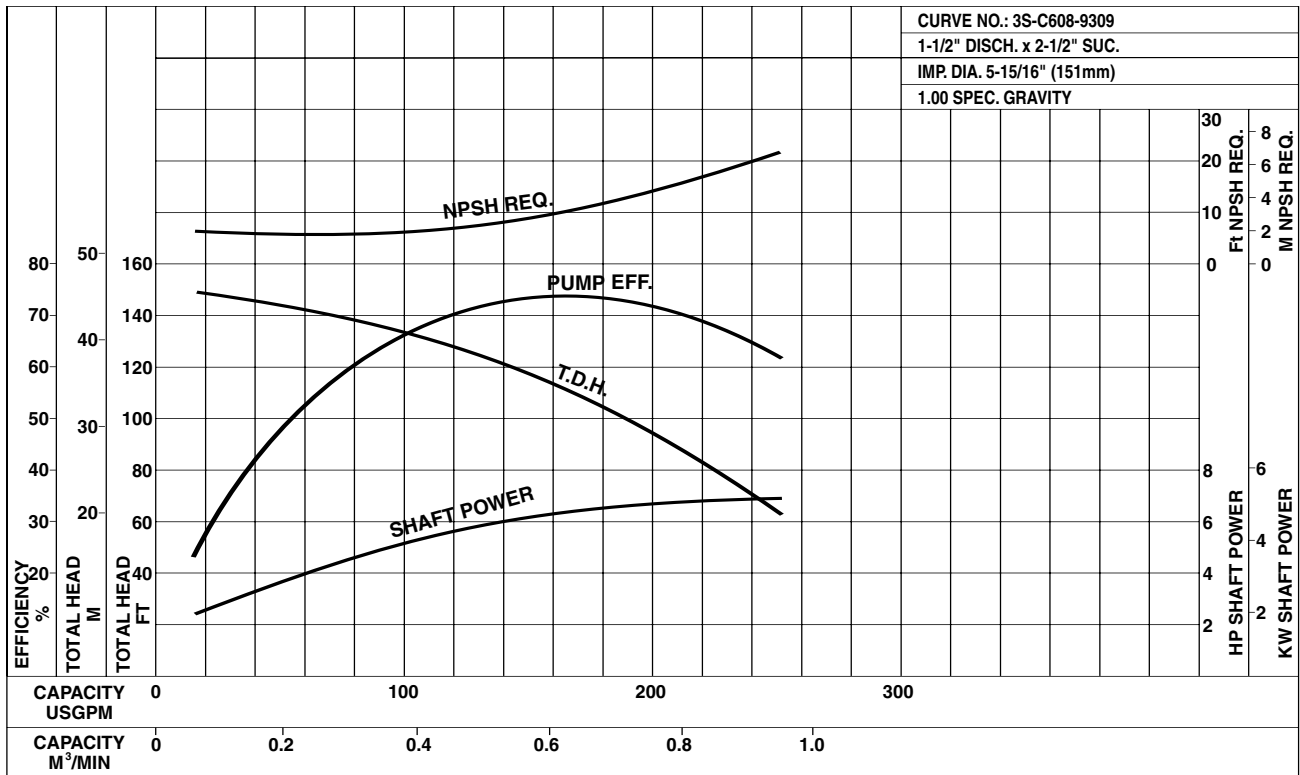

Model 3U

EBARA Stainless Steel Centrifugal Pumps

Performance Curves

3U 40-160-1-10HP

Synchronous Speed: 3450 RPM

Size: 1 1/2 x 2 1/2 x 6 9/16

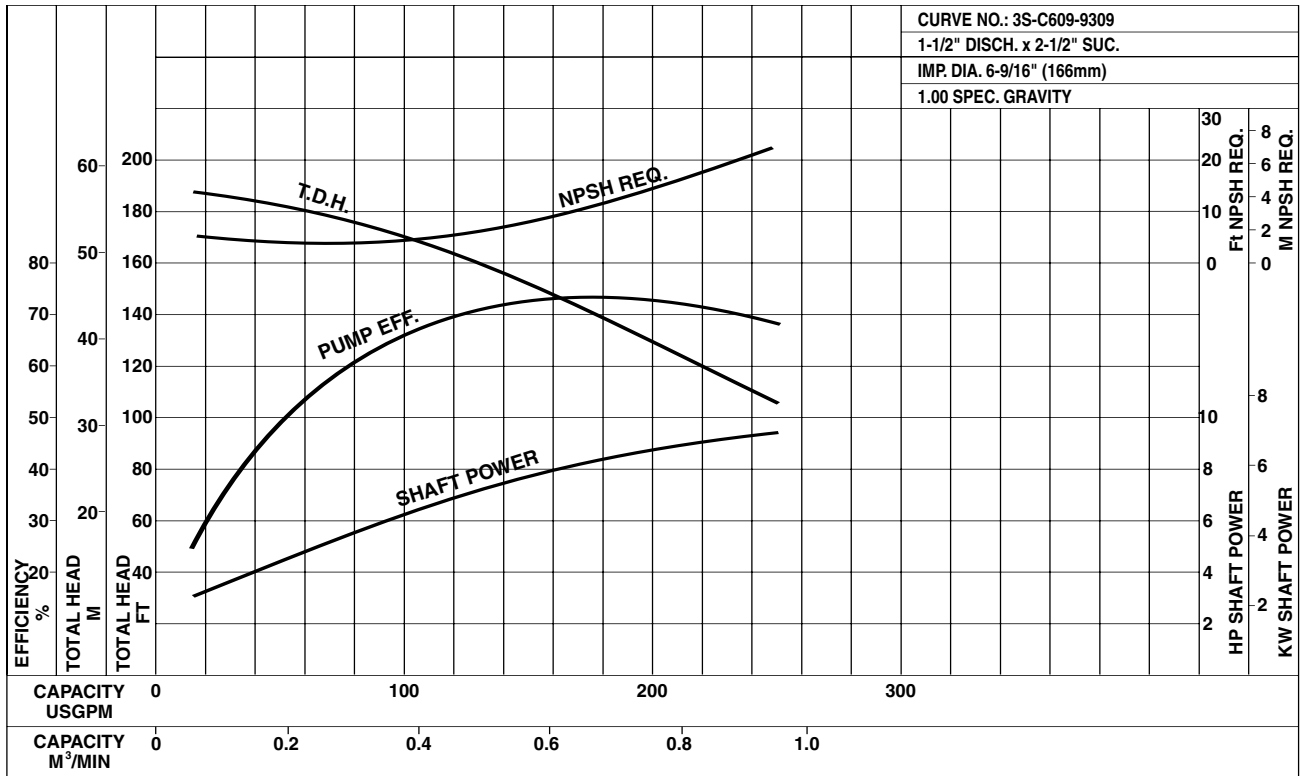

3U 40-200A-15HP

Synchronous Speed: 3450 RPM

Size: 1 1/2 x 2 1/2 x 7 3/16

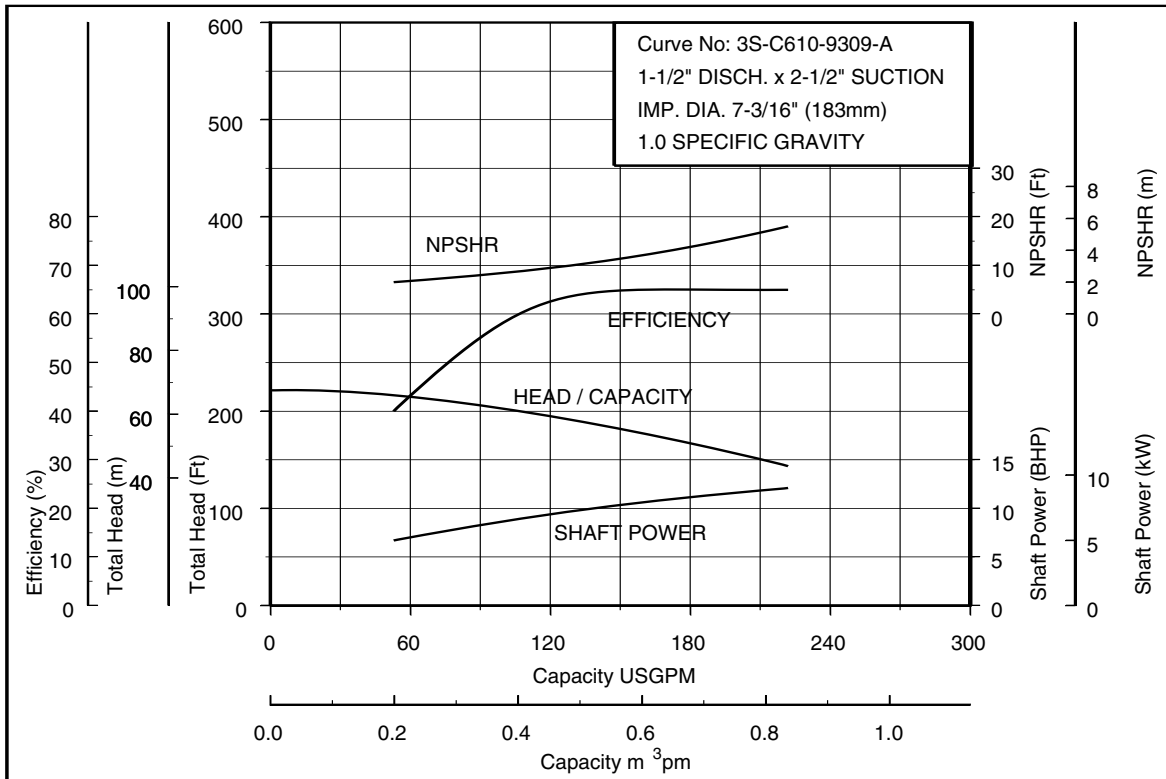

Model 3U

EBARA Stainless Steel Centrifugal Pumps

Performance Curves

3U 40-200B-15HP

Synchronous Speed: 3450 RPM

Size: 1 1/2 x 2 1/2 x 7/8

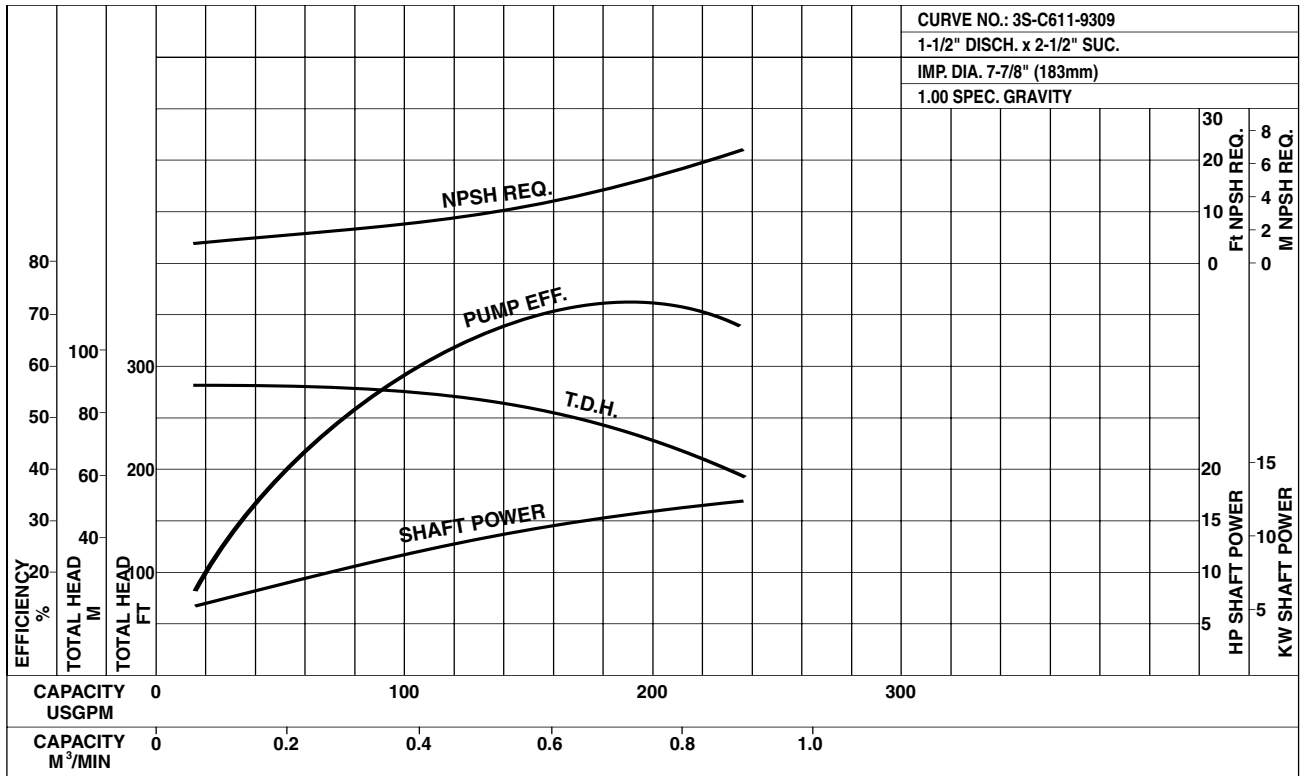

3U 50-125-7 1/2HP

Synchronous Speed: 3450 RPM

Size: 2 x 2 1/2 x 5 3/16

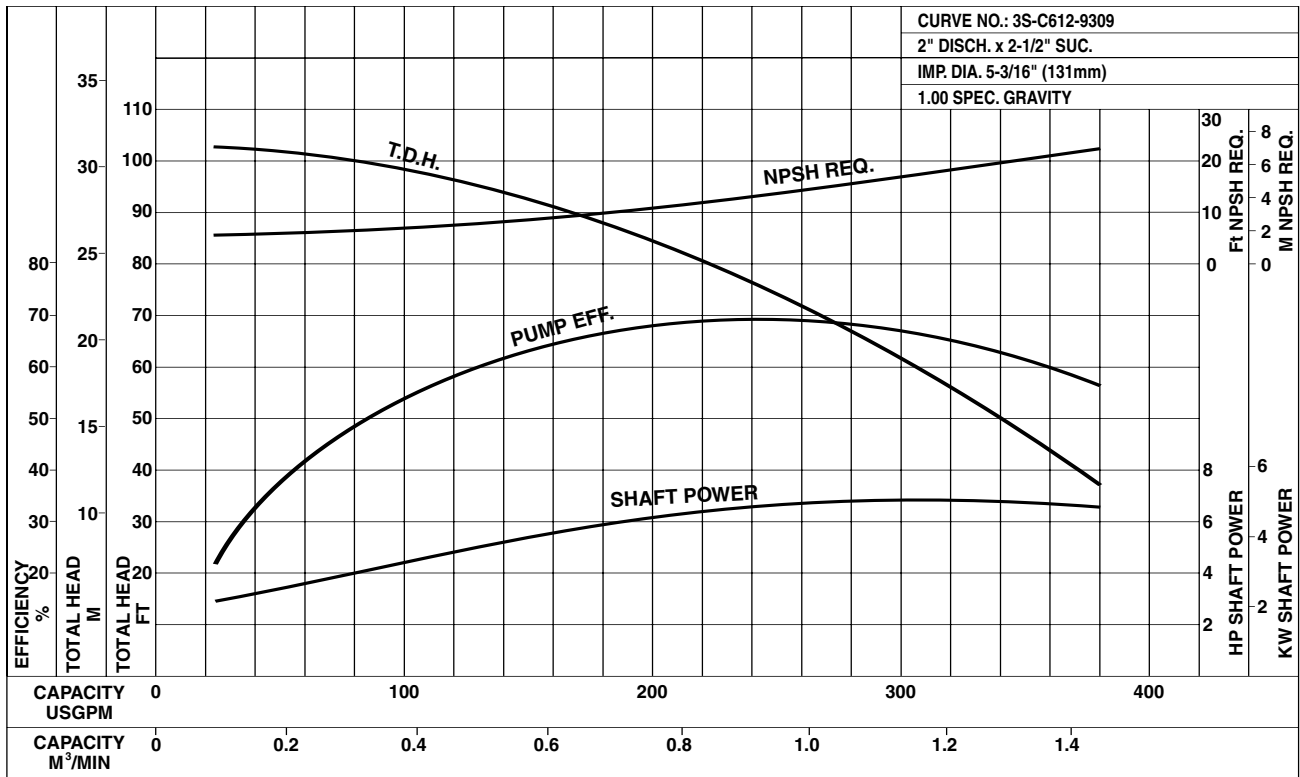

Model 3U

EBARA Stainless Steel Centrifugal Pumps

Performance Curves

3U 50-125-10HP

Synchronous Speed: 3450 RPM

Size: 2 x 2 1/2 x 5 1/2

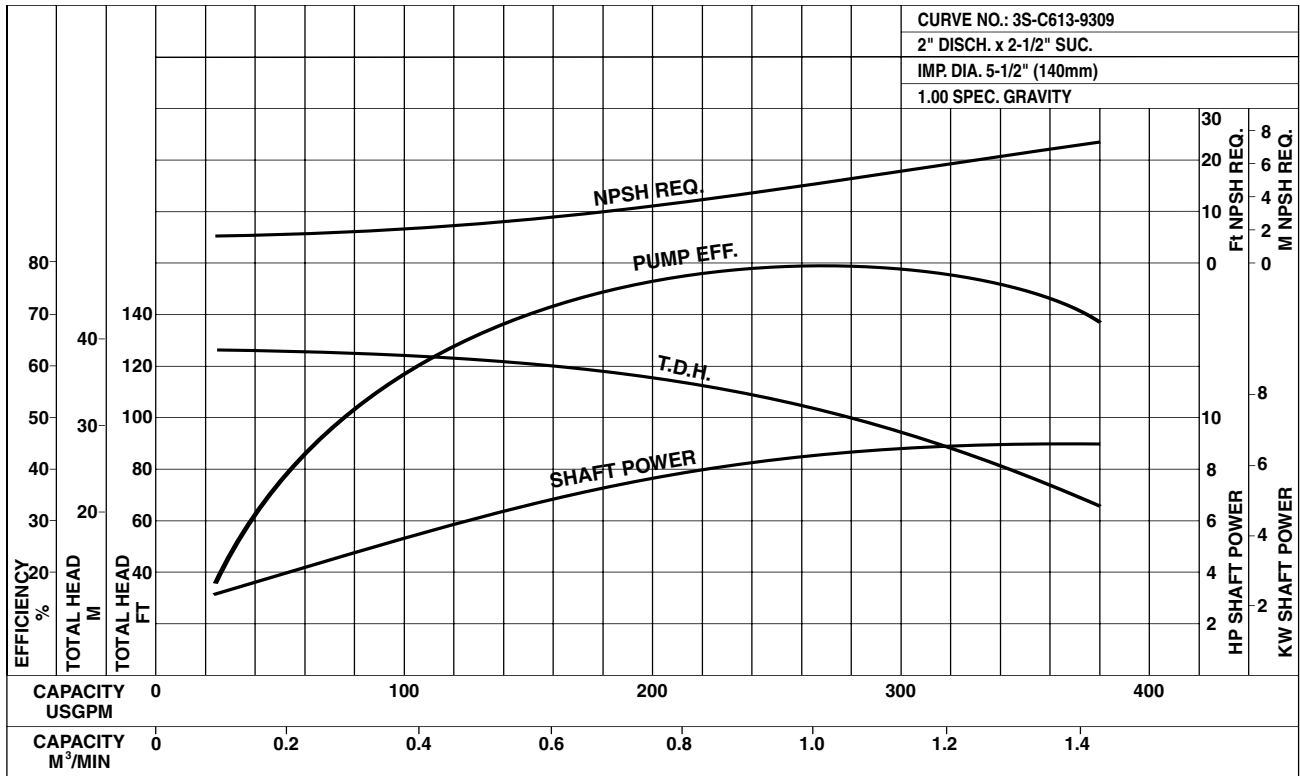

3U 50-160-10HP

Synchronous Speed: 3450 RPM

Size: 2 x 2 1/2 x 6 3/16

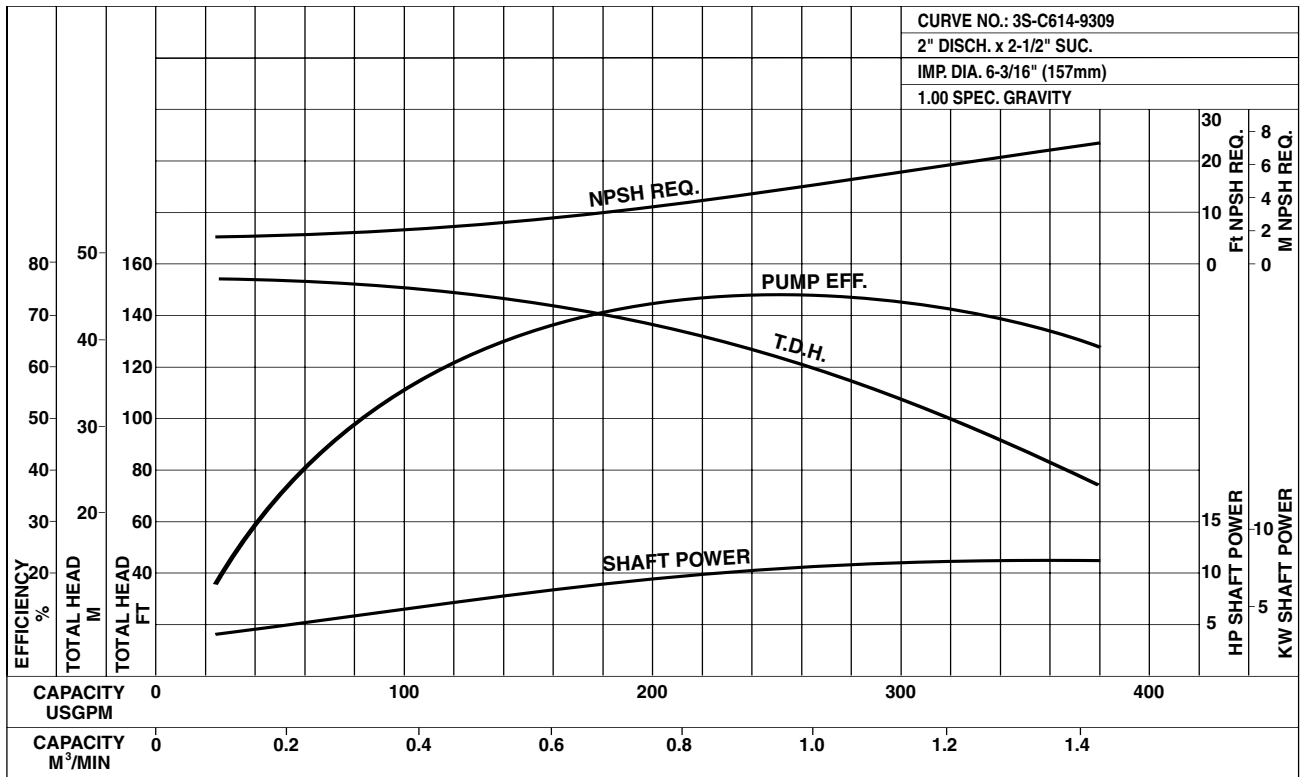

Model 3U

EBARA Stainless Steel Centrifugal Pumps

Performance Curves

3U 50-160-1-15HP

Synchronous Speed: 3450 RPM

Size: 2 x 2^{1/2} x 6^{9/16}

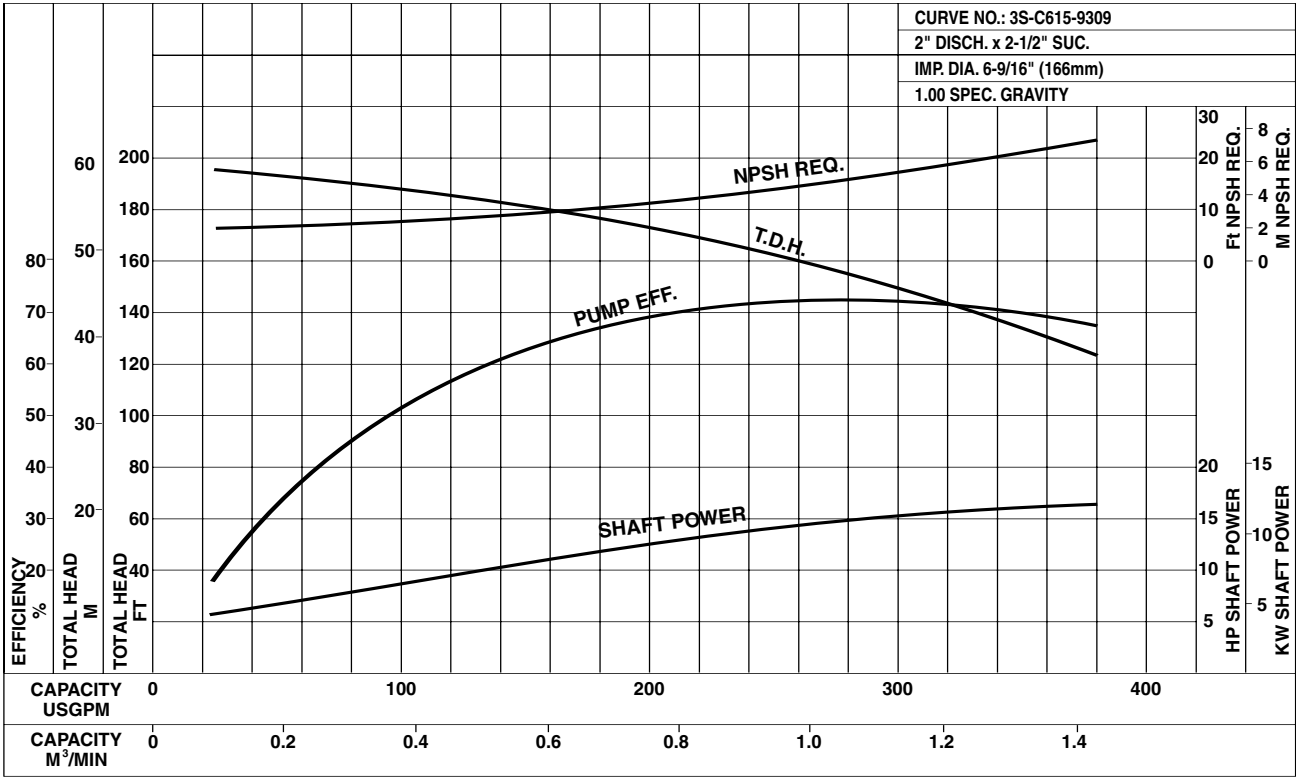

Performance Curves

3UB 65-125-7.5HP

Synchronous Speed: 3450 RPM

Size: 2 1/2 x 3 x 4 7/8 (124mm)

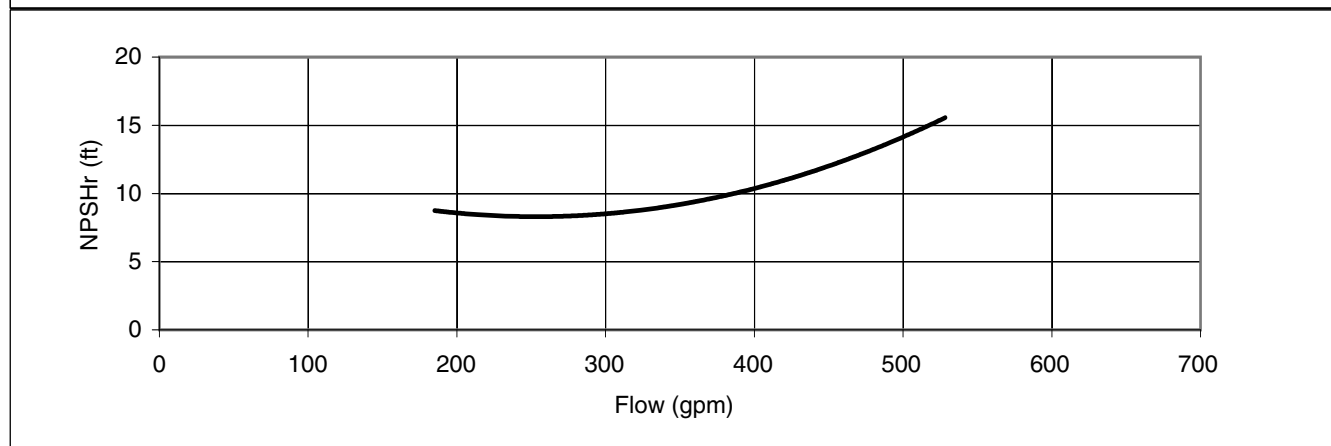
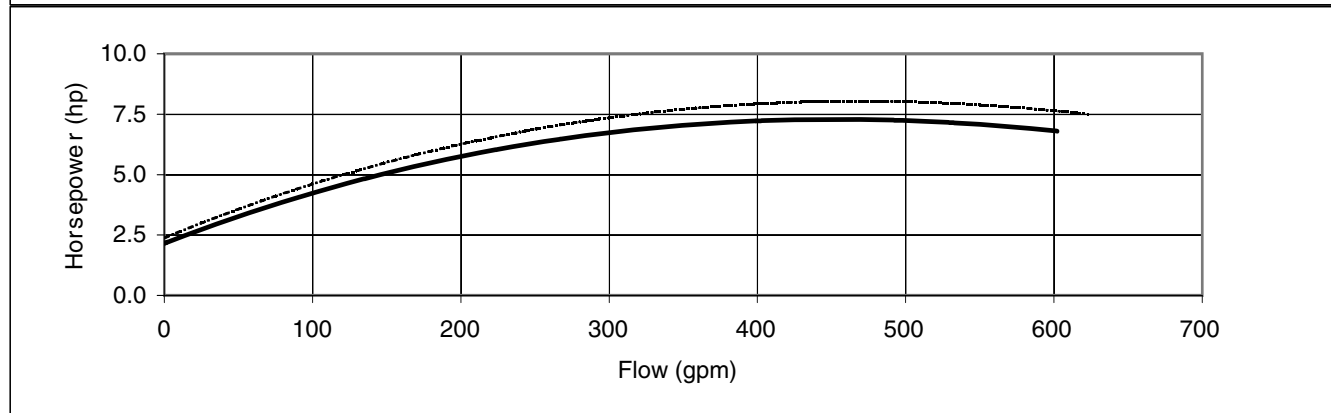
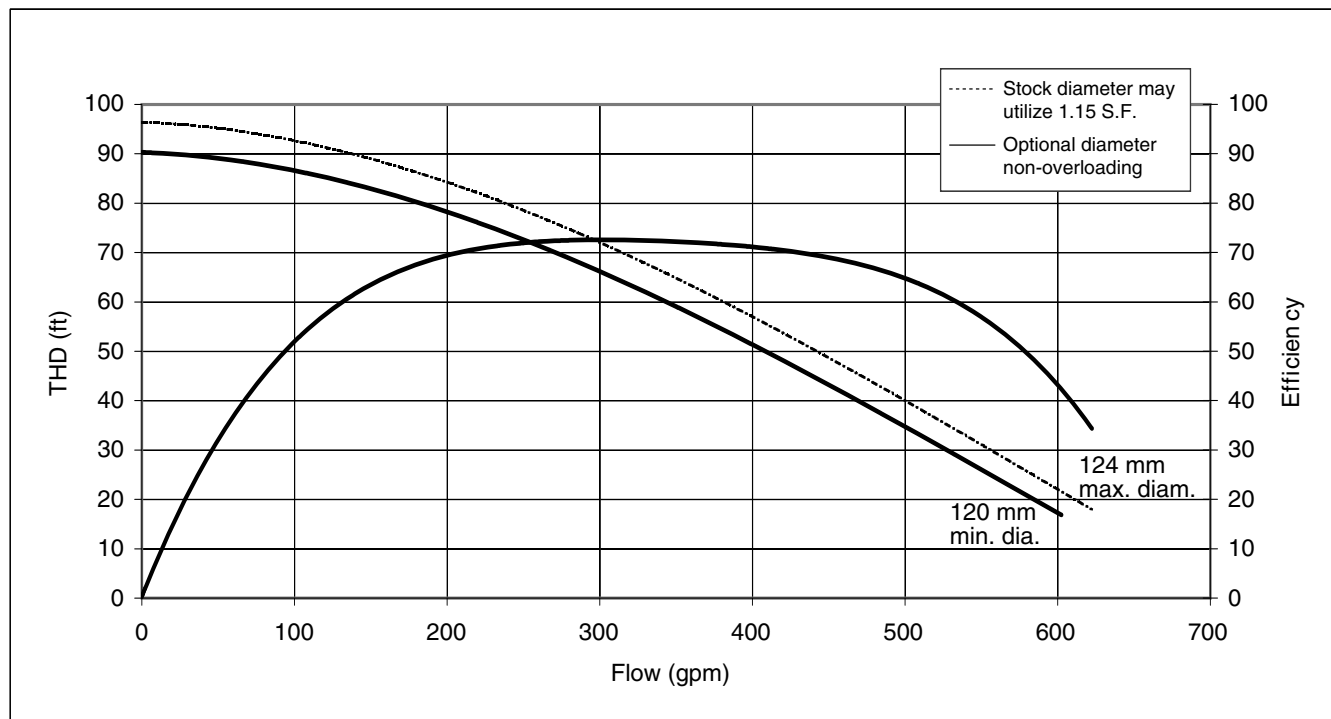

Performance curves

3UB 65-125-10HP

Synchronous Speed: 3450 RPM

Size: 2½ x 3 x 5⁵/₁₆ (135 mm)

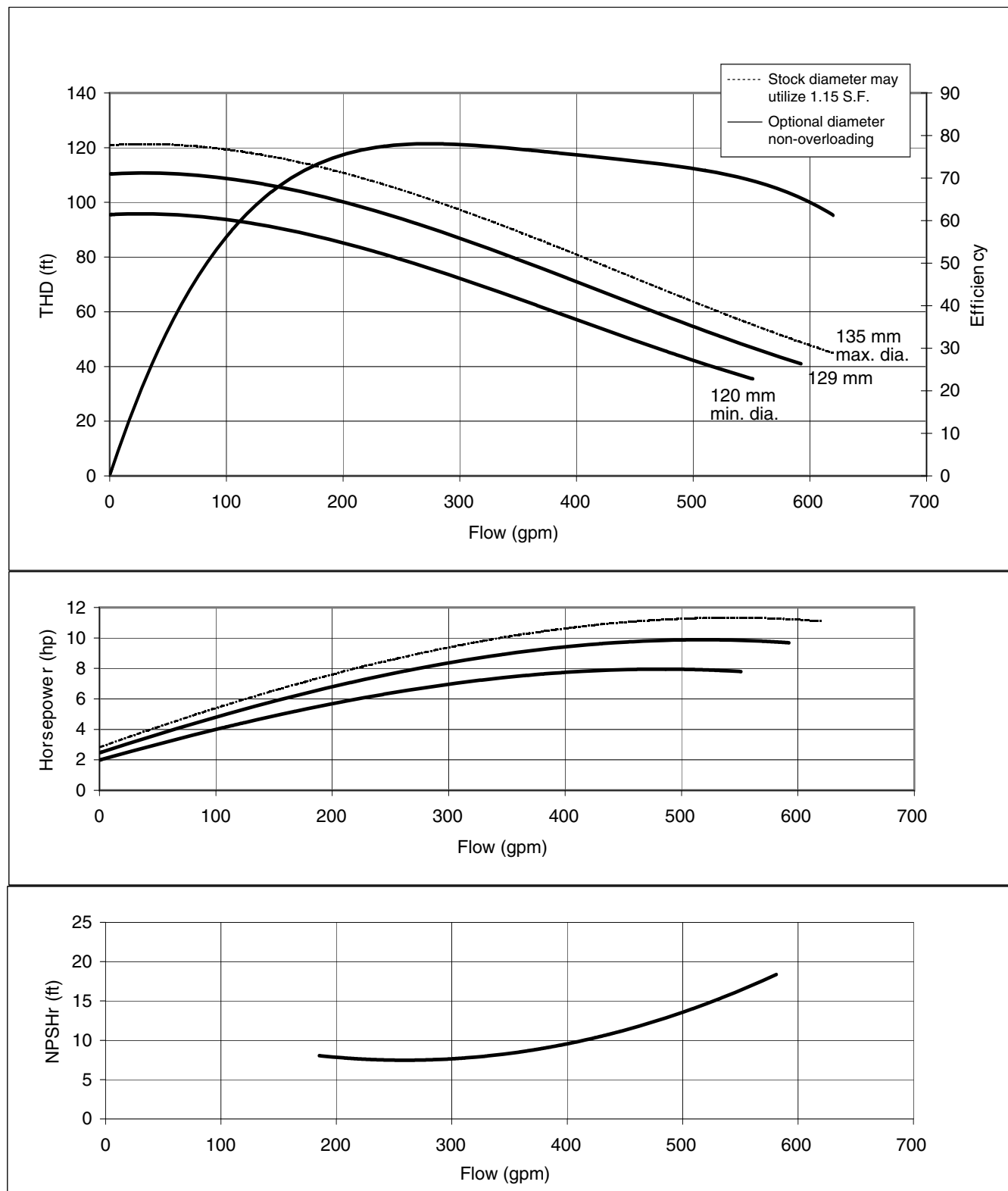

Performance curves

3UB 65-160-10HP

Synchronous Speed: 3450 RPM

Size: 2 1/2 x 3 x 5 3/8 (136mm)

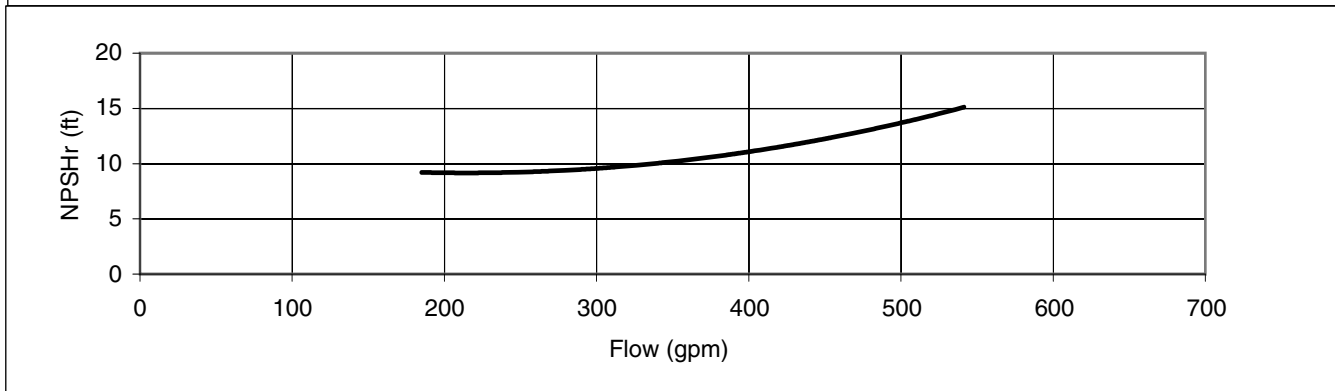
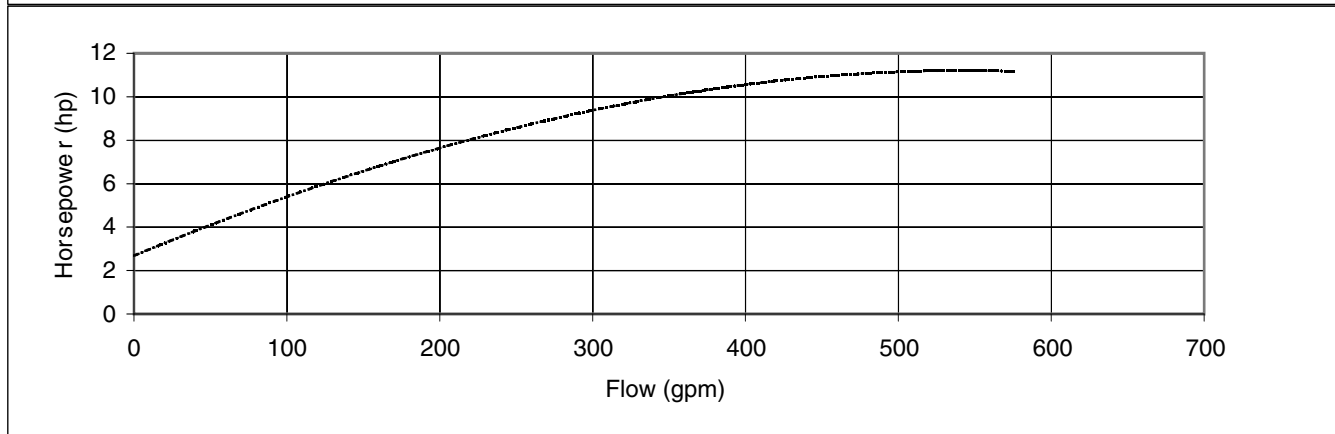
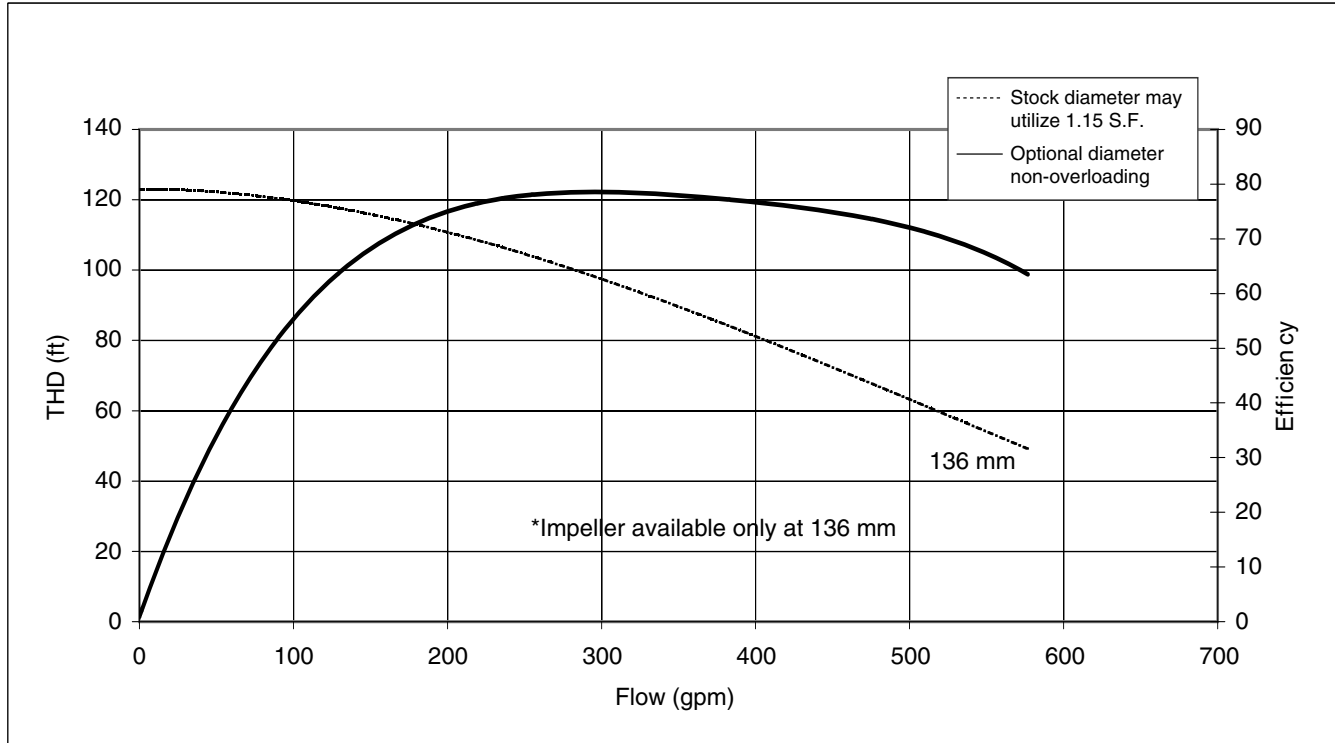

Performance Curves

3UB 65-160-15HP

Synchronous Speed: 3450 RPM

Size: 2 1/2 x 3 x 5 7/8 (150mm)

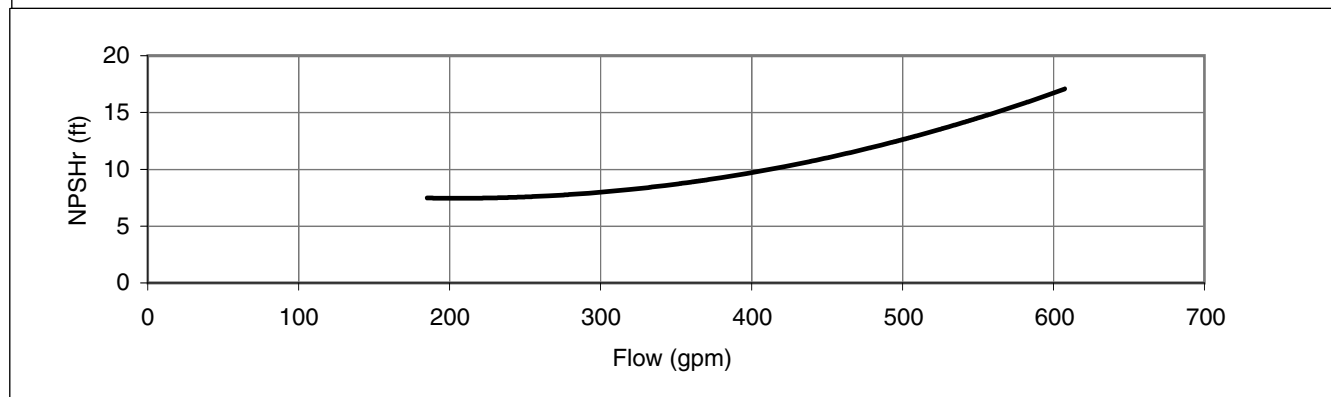
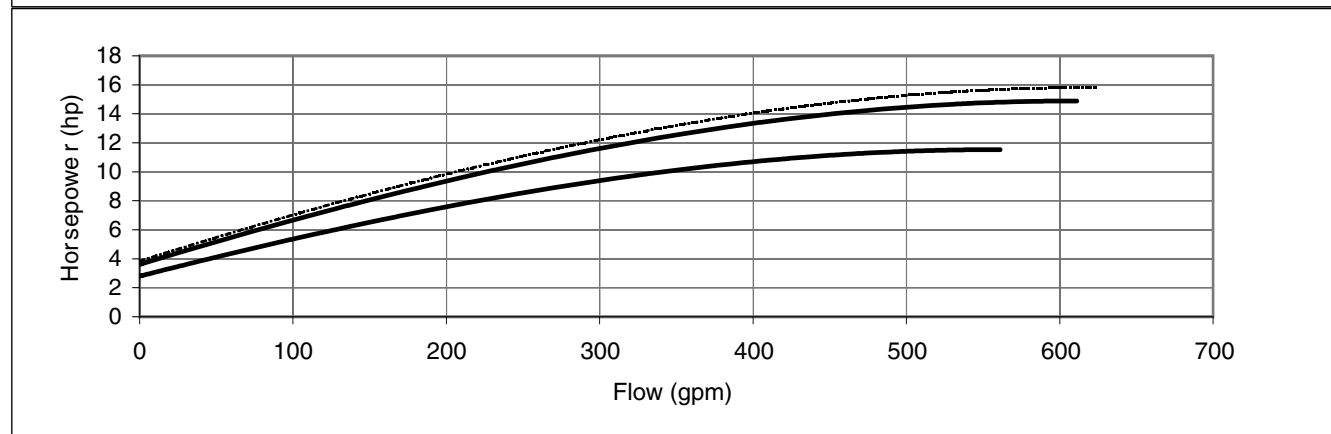
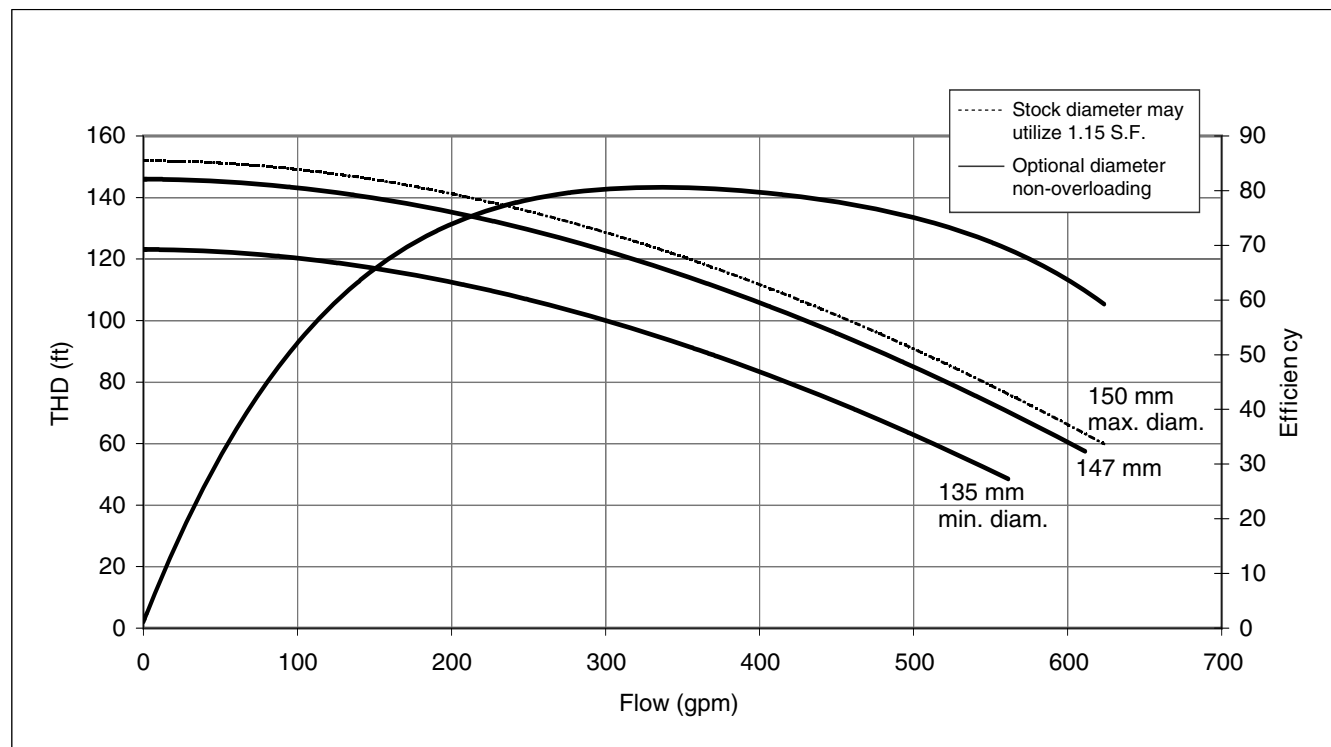

Performance Curves

3UB 65-160-20HP

Synchronous Speed: 3450 RPM

Size: 2 1/2 x 3 x 6 5/16 (160mm)

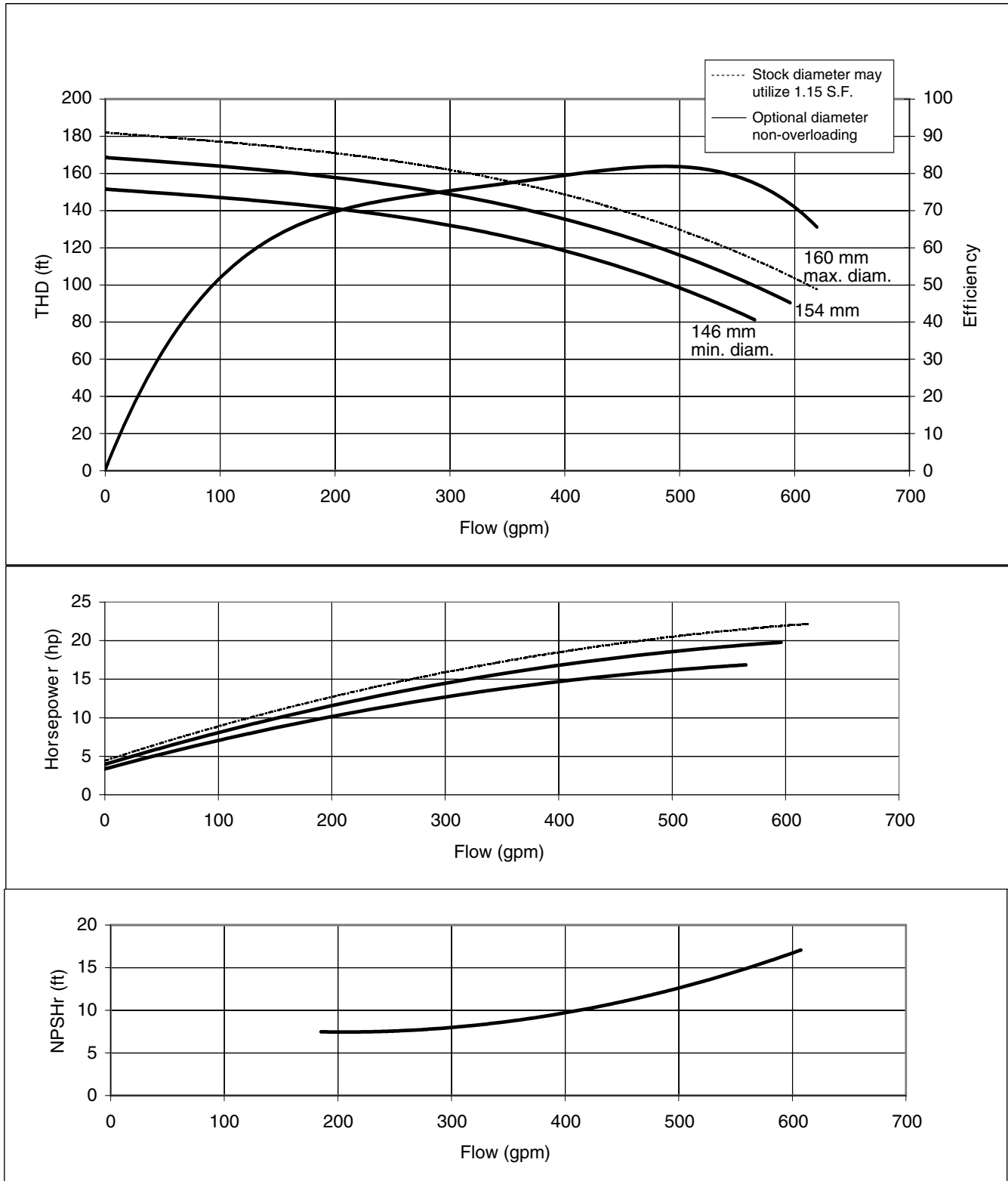

Performance Curves

3UB 65-160-25HP

Synchronous Speed: 3450 RPM

Size: 2 1/2 x 3 x 6 7/8 (174mm)

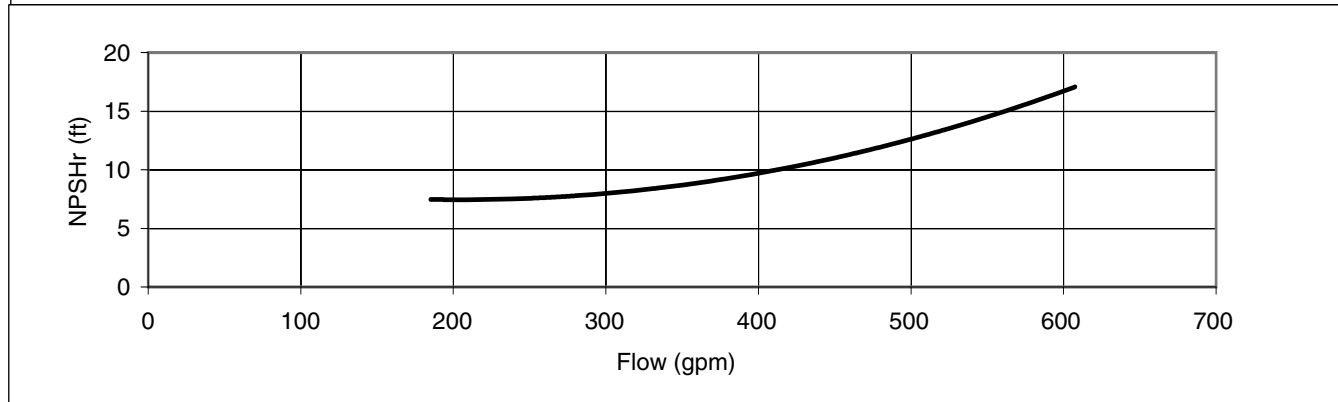
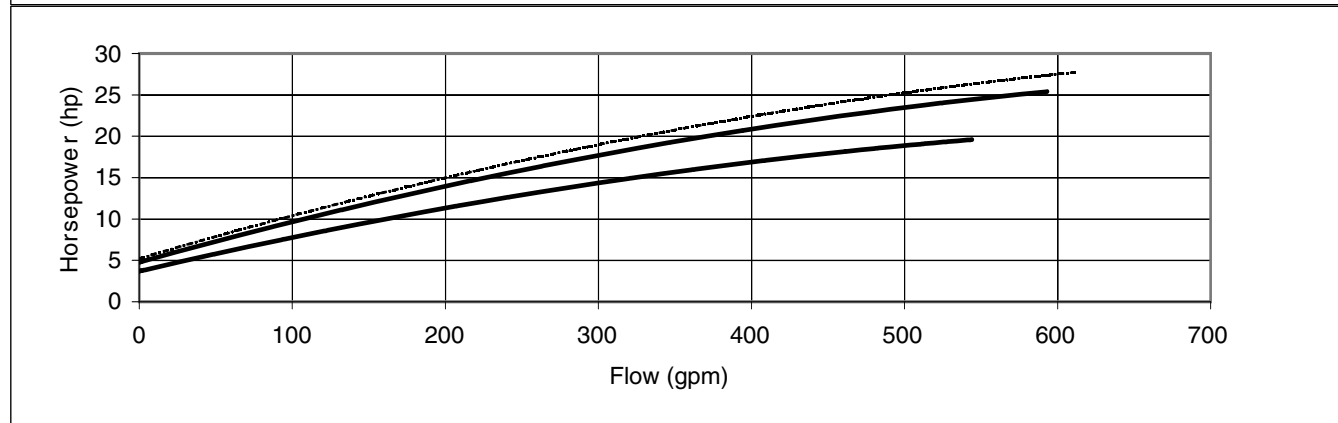
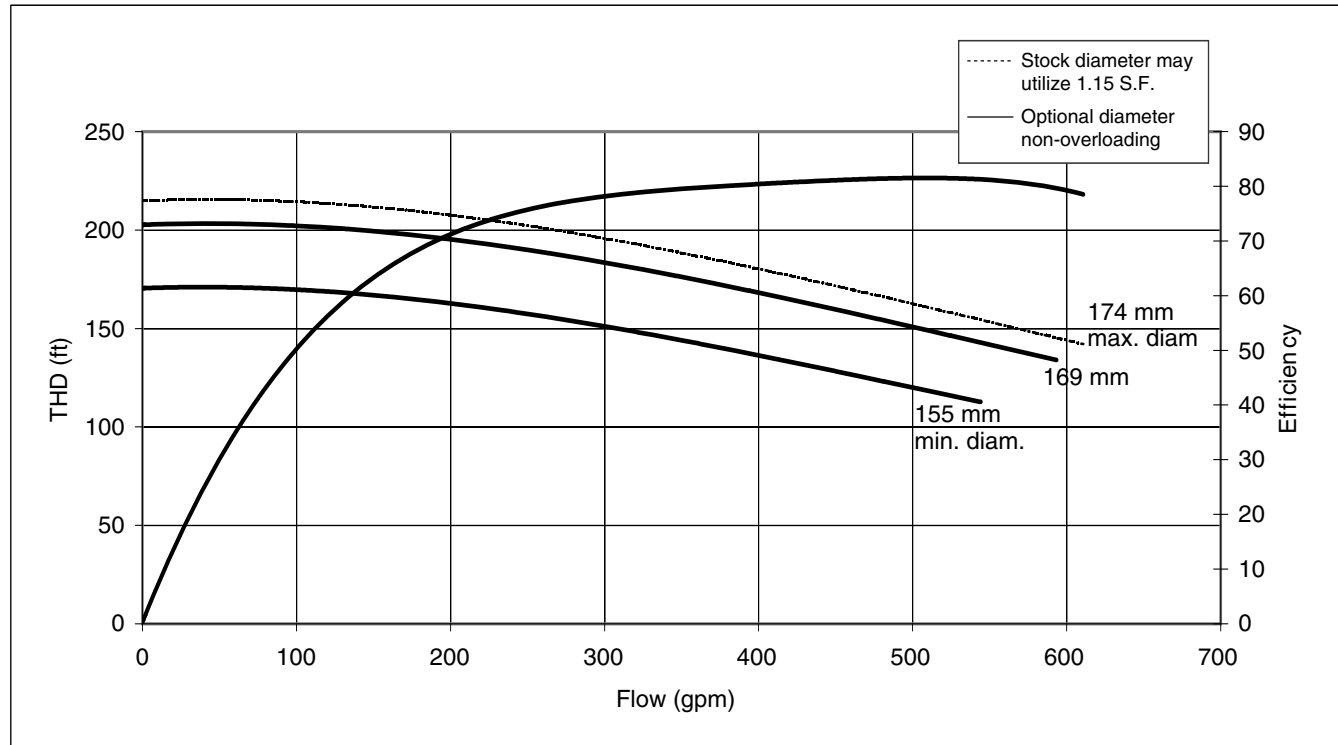

Performance Curves

3UB 65-200-20HP

Synchronous Speed: 3450 RPM

Size: 2 1/2 x 3 x 6 3/4 (171mm)

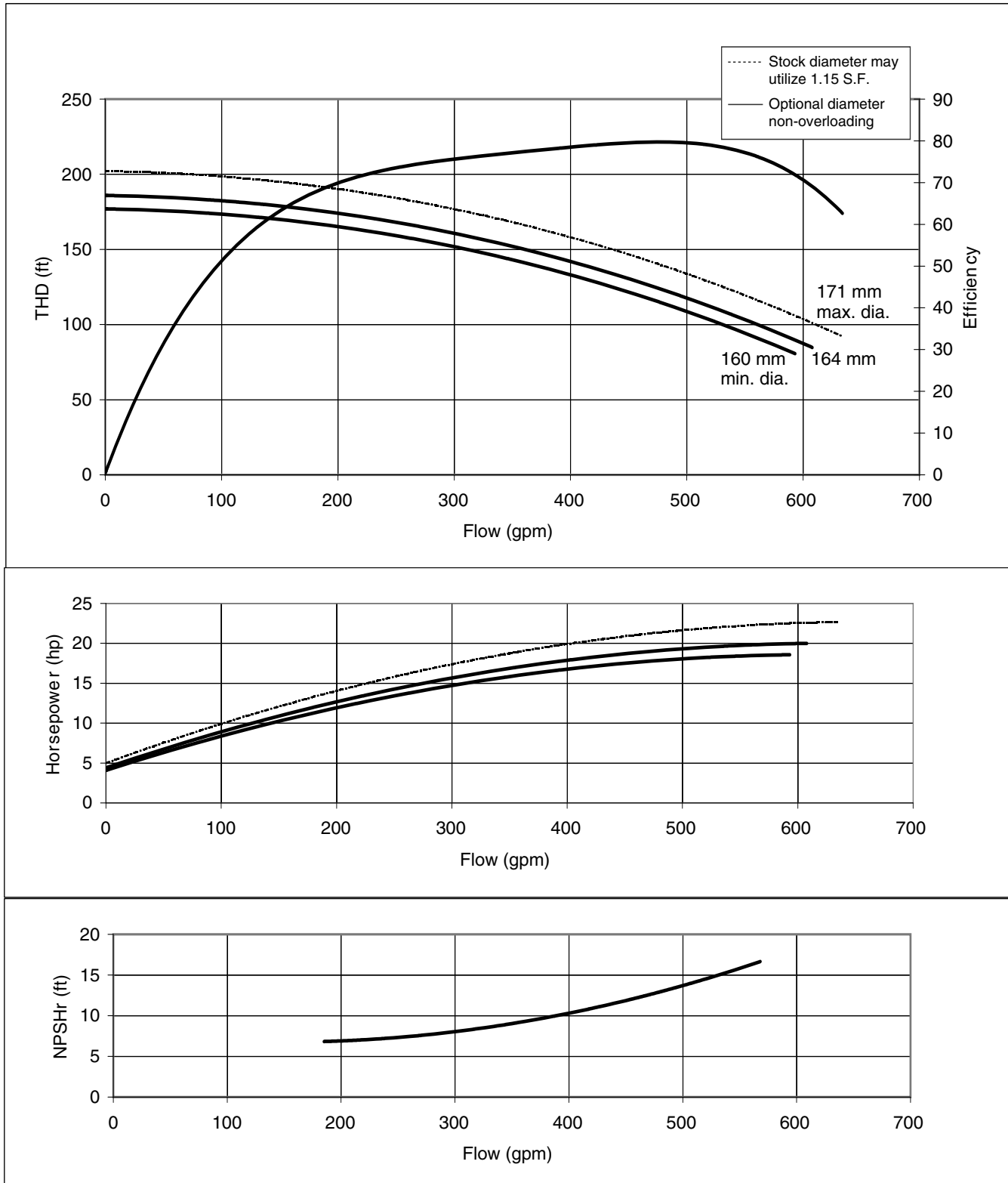

3UB 65-200-25HP

Synchronous Speed: 3450 RPM

Size: 2½ x 3 x 7 (179mm)

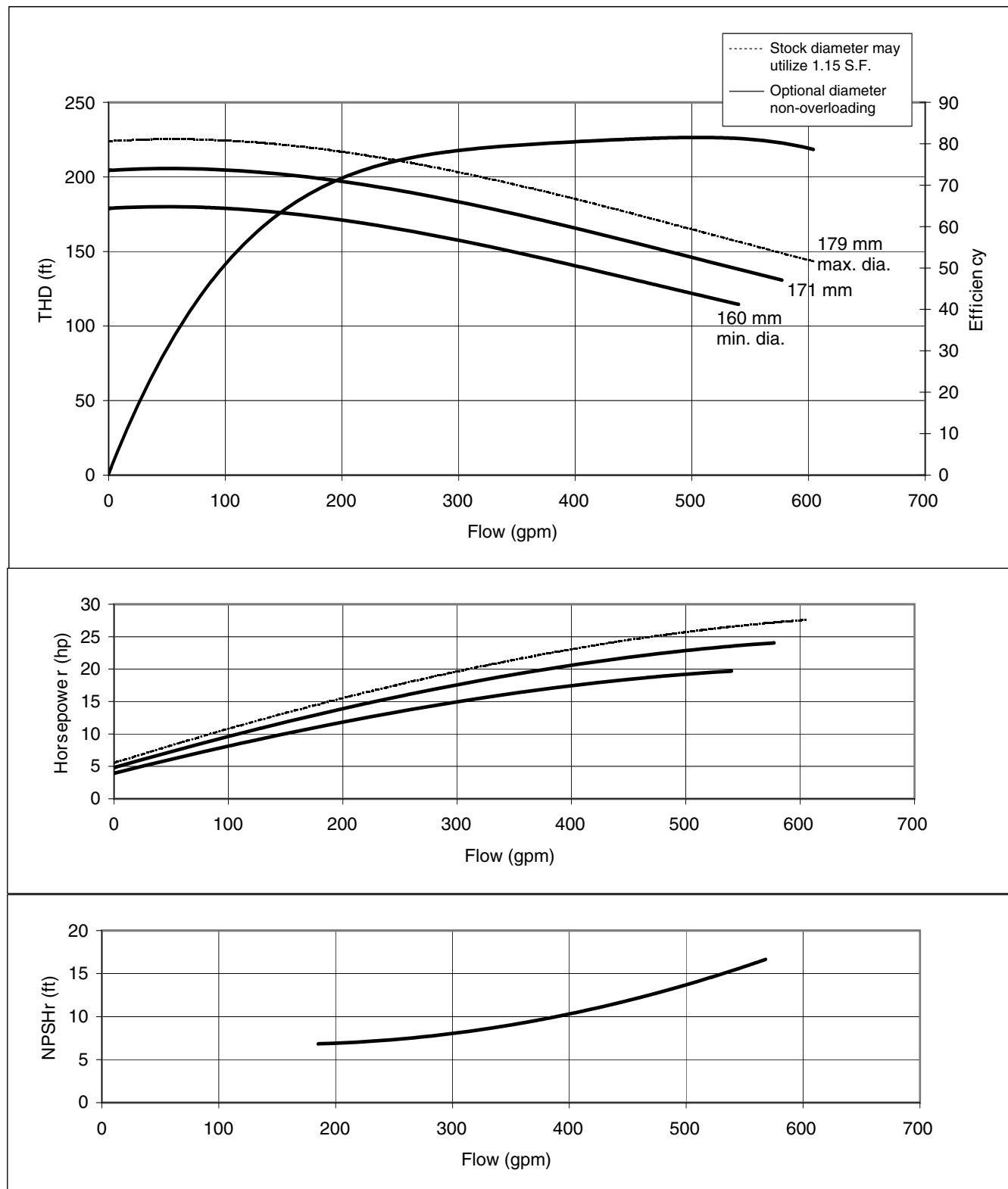

Performance Curves

3UB 65-200-30HP

Synchronous Speed: 3450 RPM

Size: 2 1/2 x 3 x 7 1/2 (190mm)

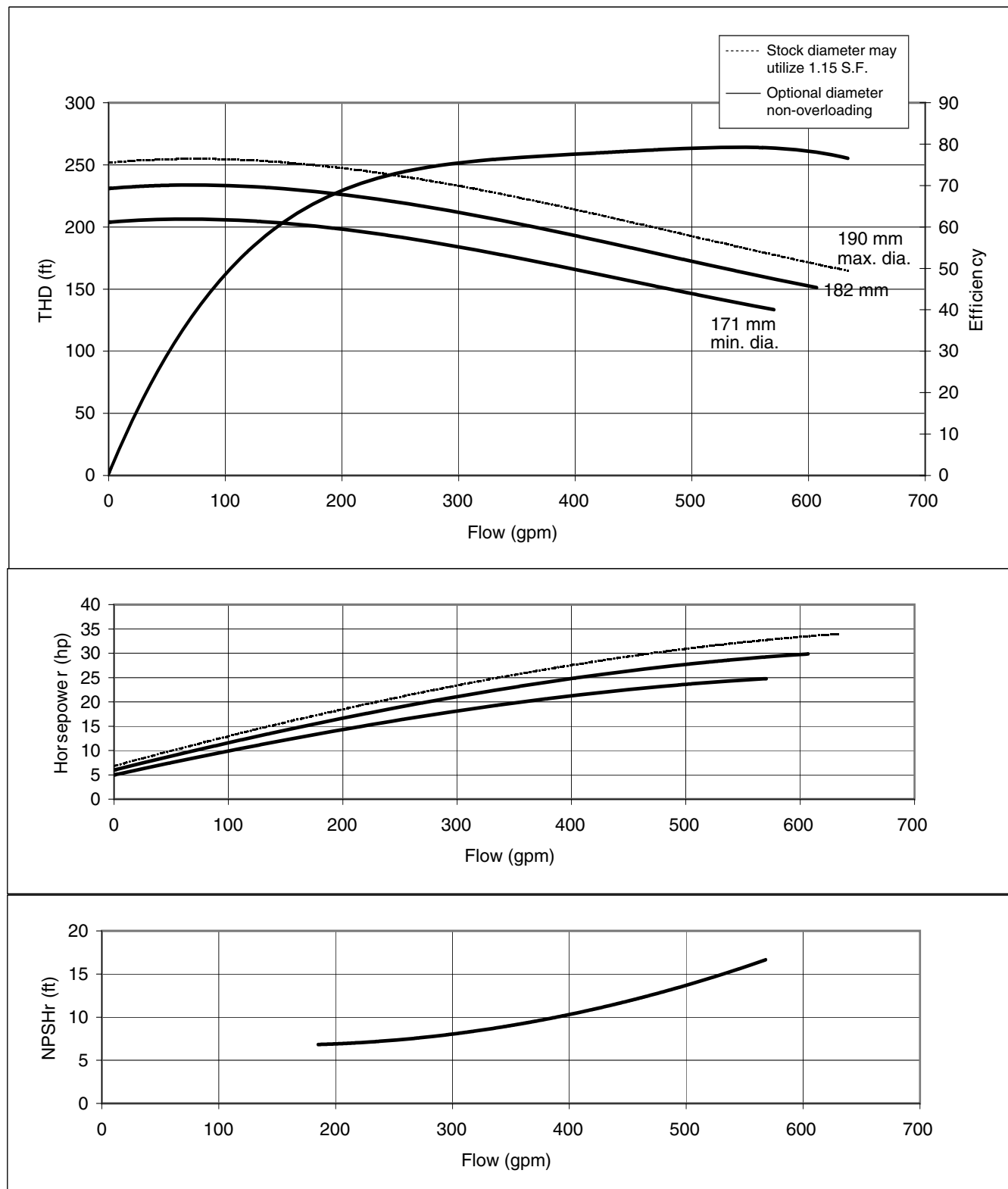

Selection chart

Synchronous Speed 1725 RPM

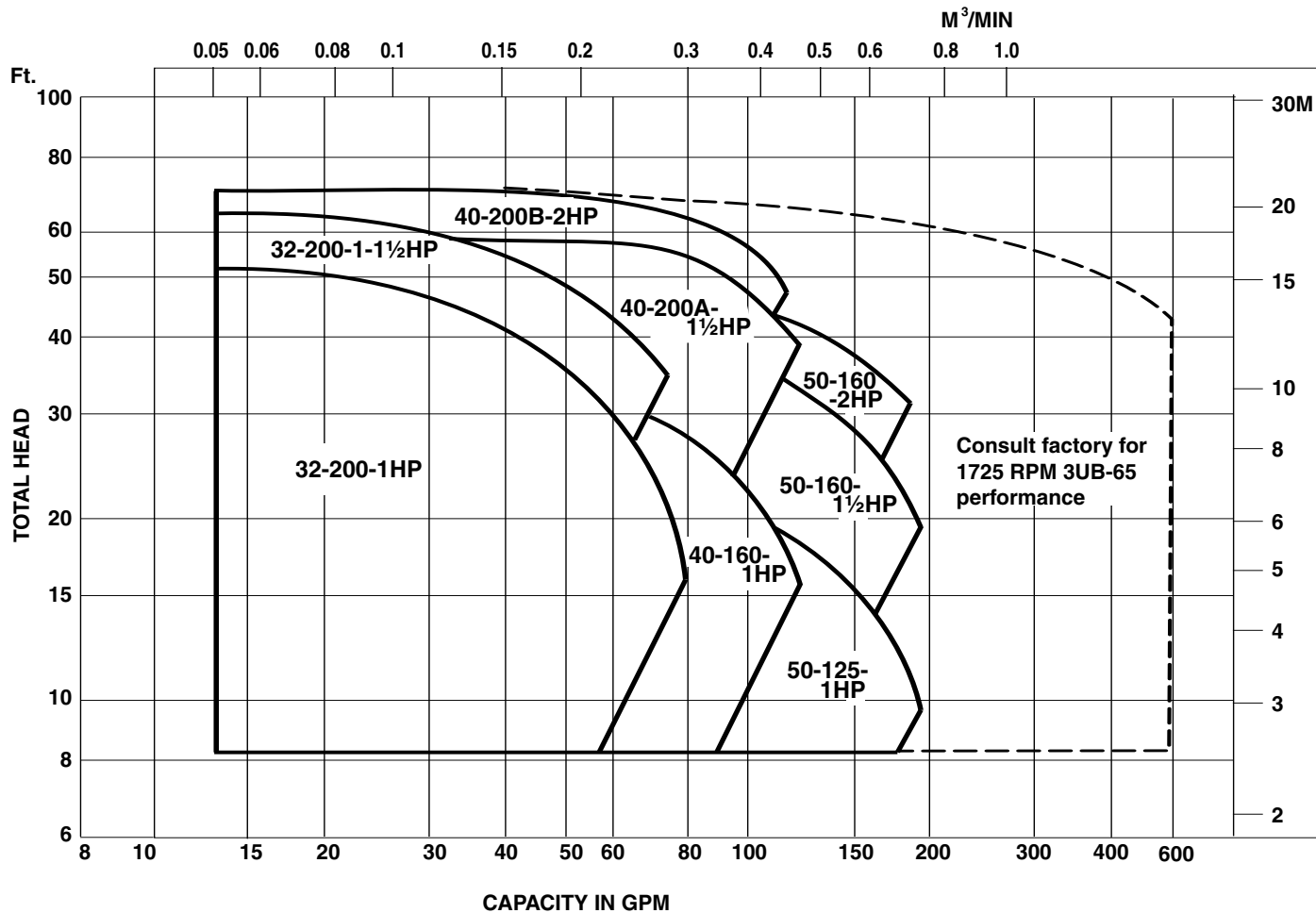

Model 3U

EBARA Stainless Steel Centrifugal Pumps

Performance Curves

3U4 32-200-1HP

Synchronous Speed: 1725 RPM

Size: 1 1/4 x 2 x 7 5/16

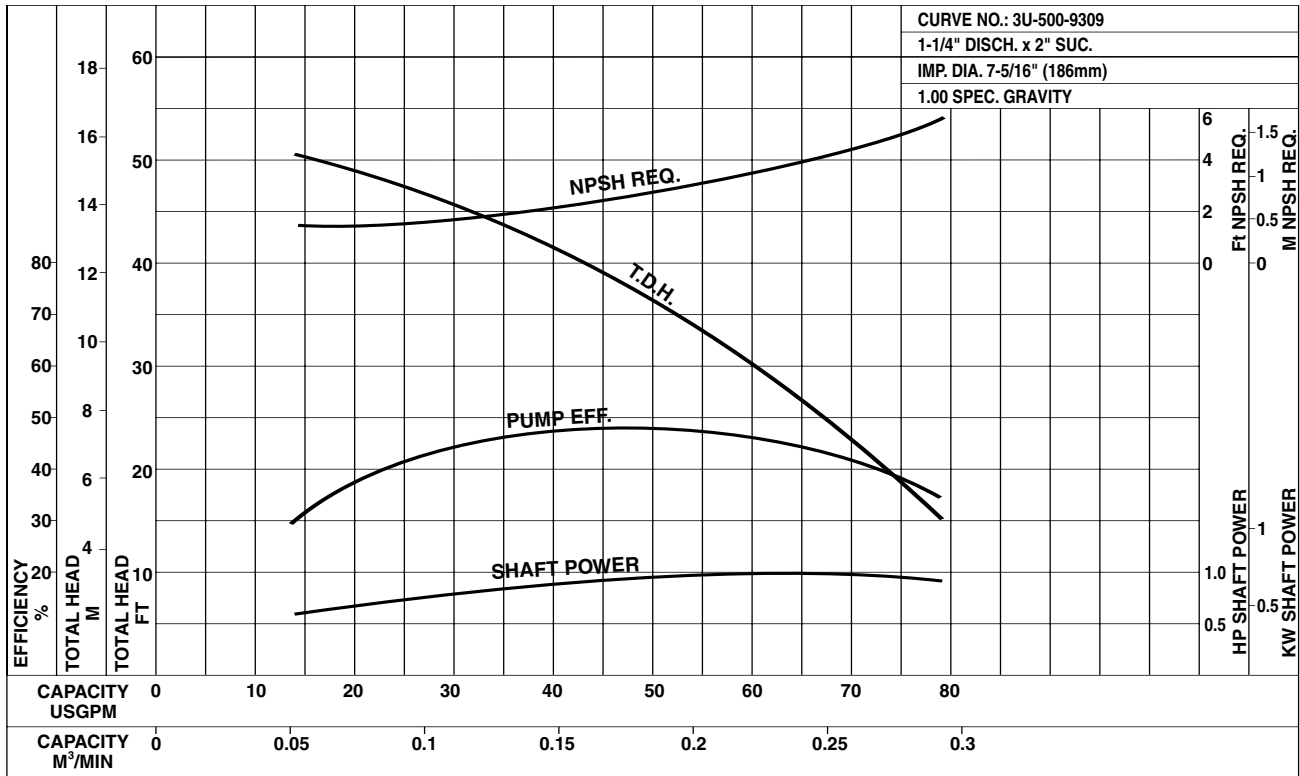

3U4 32-200-1-1 1/2HP

Synchronous Speed: 1725 RPM

Size: 1 1/4 x 2 x 7 7/8

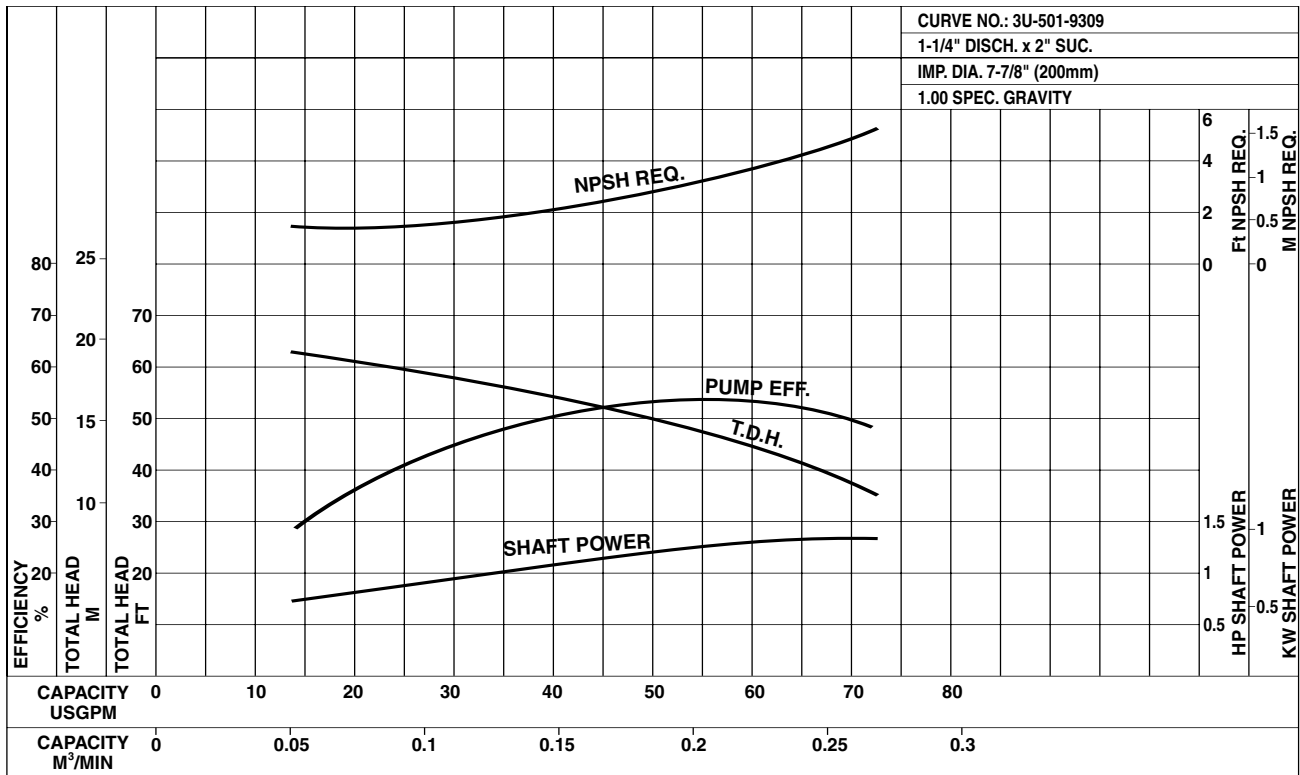

Model 3U

EBARA Stainless Steel Centrifugal Pumps

Performance Curves

3U4 40-160-1HP

Synchronous Speed: 1725 RPM

Size: 1 1/2 x 2 1/2 x 5 15/16

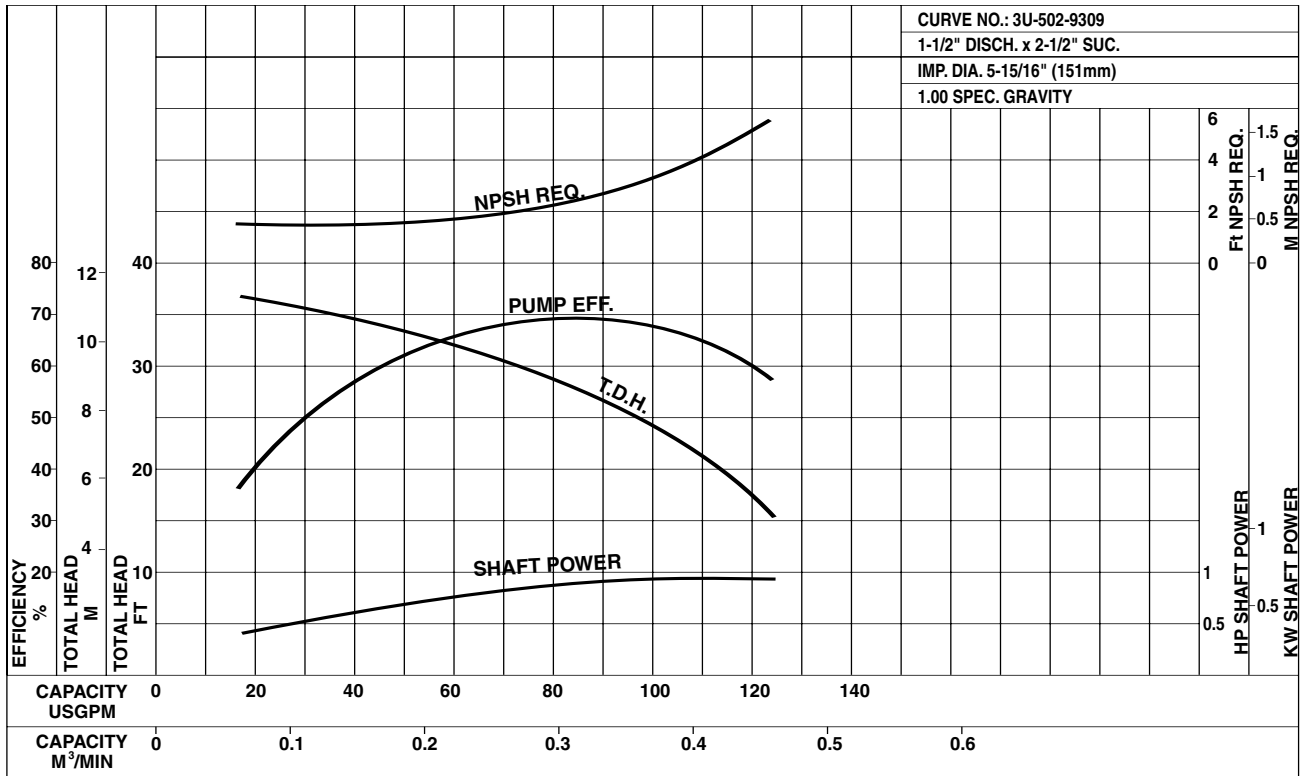

3U4 40-200A-1 1/2HP

Synchronous Speed: 1725 RPM

Size: 1 1/2 x 2 1/2 x 7 3/16

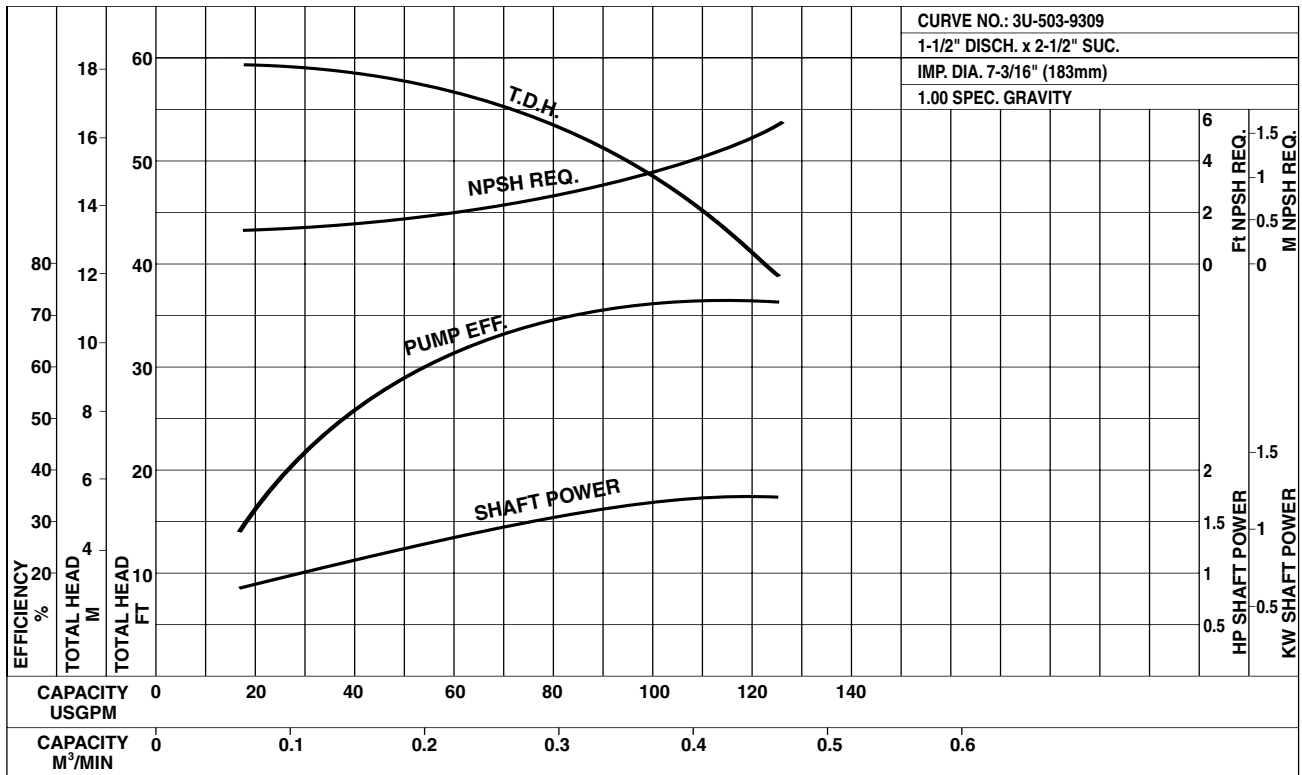

Model 3U

EBARA Stainless Steel Centrifugal Pumps

Performance Curves

3U4 40-200B-2HP

Synchronous Speed: 1725 RPM

Size: 1 1/2 x 2 1/2 x 7/8

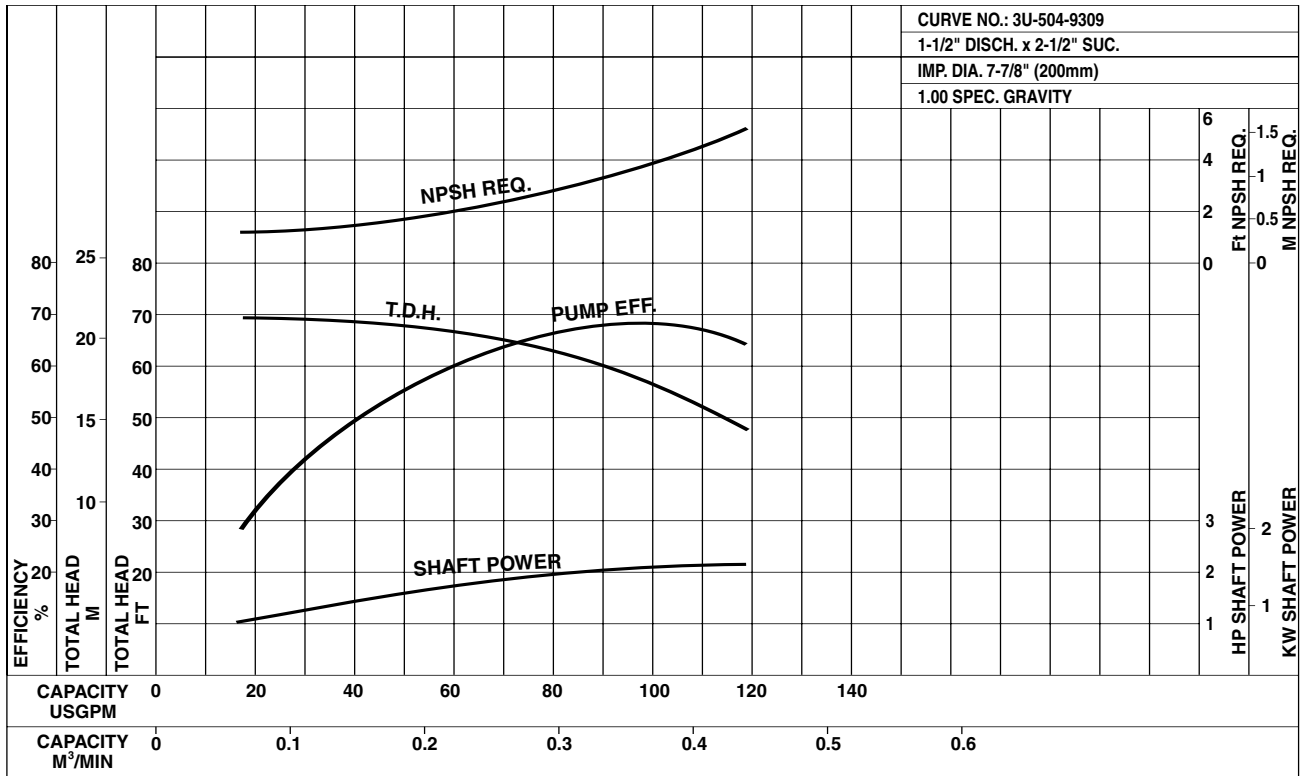

3U4 50-125-1HP

Synchronous Speed: 1725 RPM

Size: 2 x 2 1/2 x 5 3/16

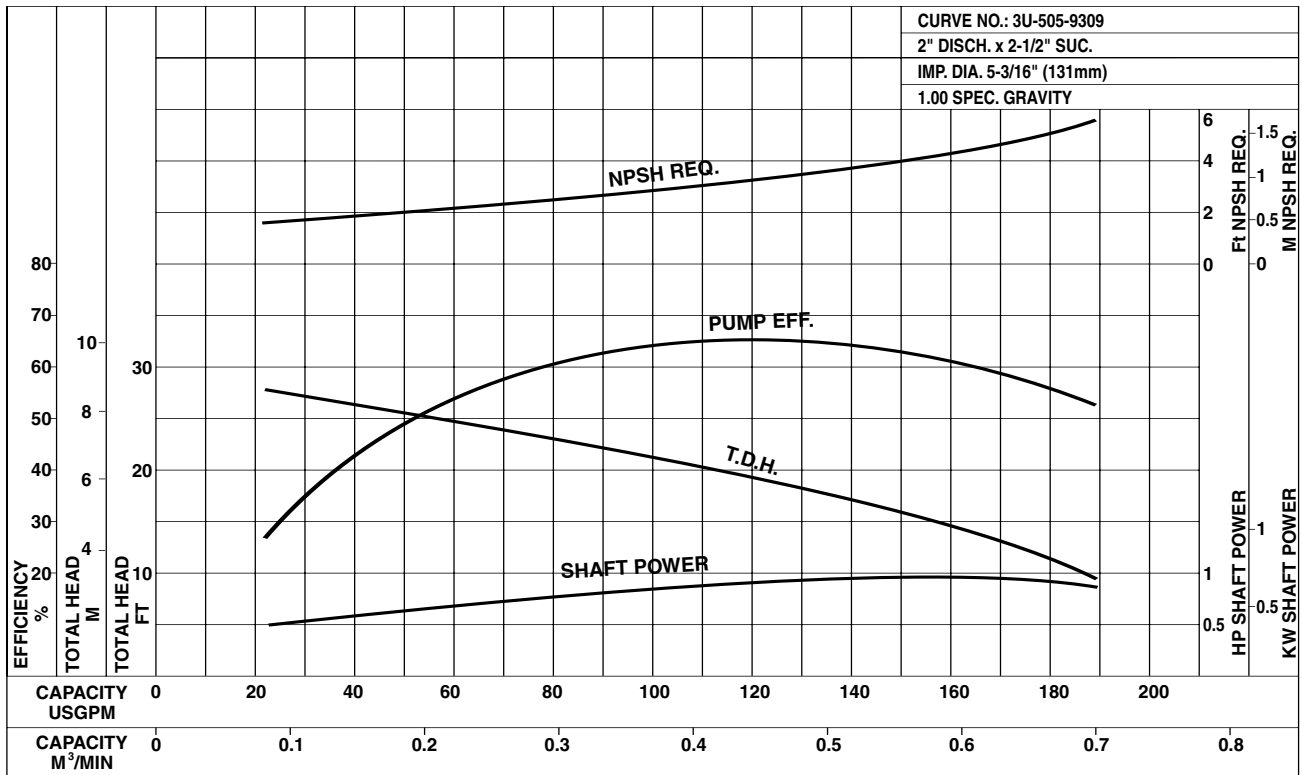

Model 3U

EBARA Stainless Steel Centrifugal Pumps

Performance Curves

3U4 50-160-1¹/₂HP

Synchronous Speed: 1725 RPM

Size: 2 x 2¹/₂ x 6³/₁₆

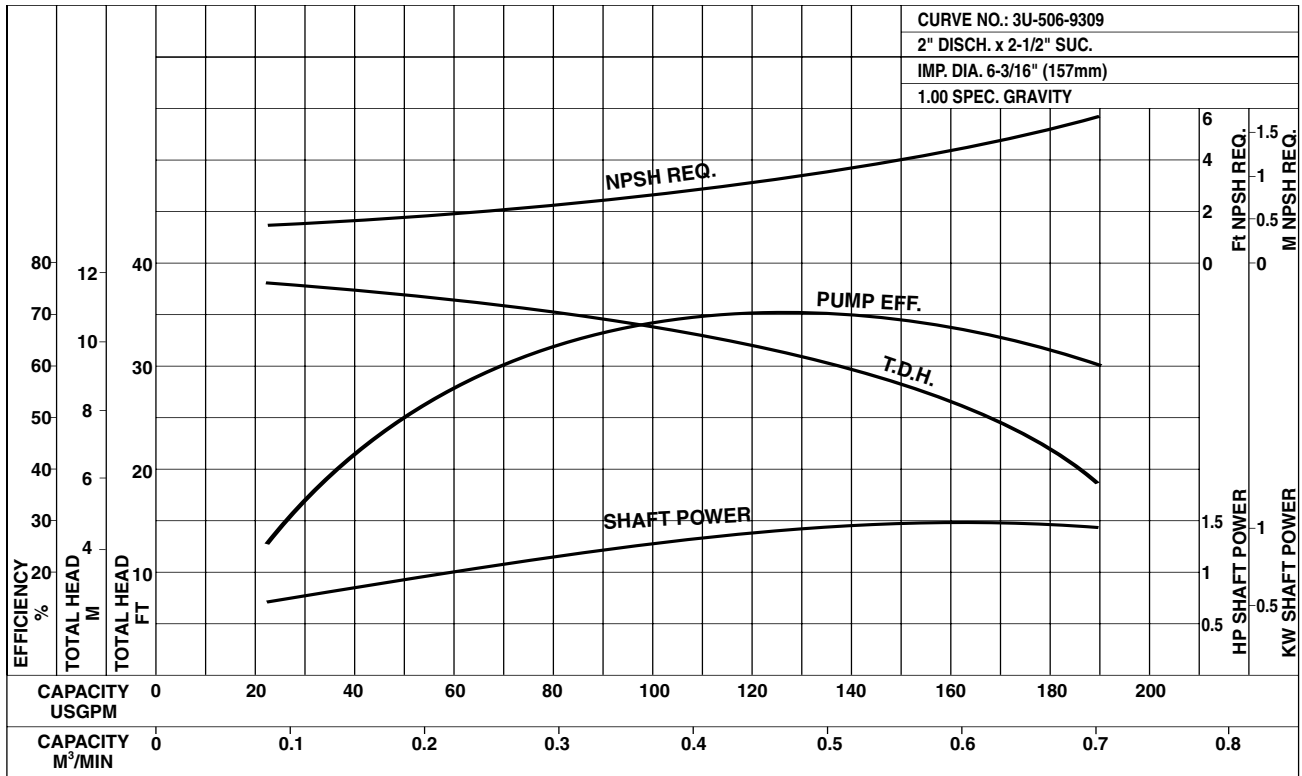

3U4 50-160-1-2HP

Synchronous Speed: 1725 RPM

Size: 2 x 2¹/₂ x 6⁹/₁₆

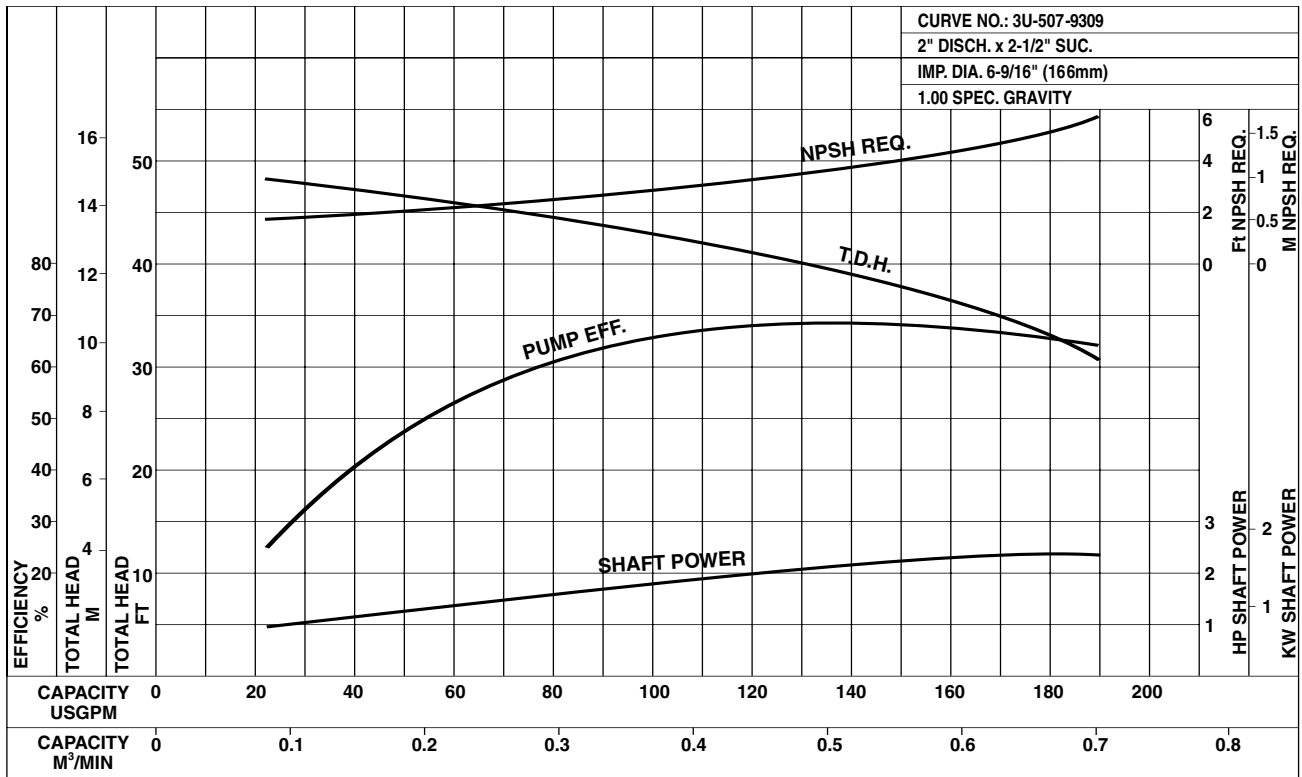

Model 3U

EBARA Stainless Steel Centrifugal Pumps

Pump Dimensions

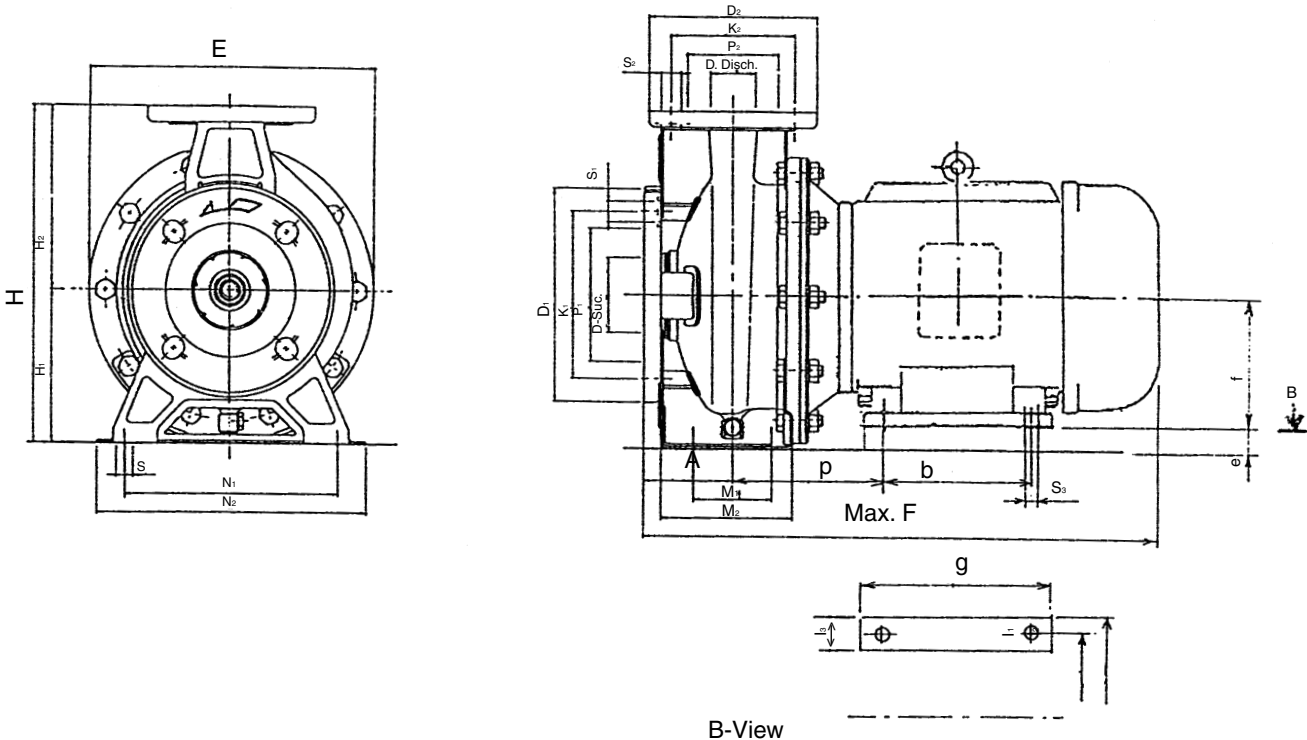

B-View

Unit: inch

Model	Size	Flange										Pump									
		Suction					Discharge														
		D Suc.	P ₁	K ₁	D ₁	S ₁	D Disch.	P ₂	K ₂	D ₂	S ₂	A	E	H	H ₁	H ₂	M ₁	M ₂	N ₁	N ₂	S
32-125-3HP	1 1/4 x 2 x 5 3/16	2	3 3/4	4 15/16	6 1/2	1 1/16	1 1/4	2 1/2	3 1/2	5 1/2	5/8	3 1/8	8 3/8	9 15/16	4 7/16	5 1/2	2 3/4	4 1/2	5 1/2	7 1/2	9/16
32-160A-5HP	1 1/4 x 2 x 5 15/16	2	3 3/4	4 15/16	6 1/2	1 1/16	1 1/4	2 1/2	3 1/2	5 1/2	5/8	3 1/8	10	11 1/2	5 3/16	6 5/16	2 3/4	4 5/8	7 1/2	9 7/16	9/16
32-160B-5HP	1 1/4 x 2 x 6 9/16	2	3 3/4	4 15/16	6 1/2	1 1/16	1 1/4	2 1/2	3 1/2	5 1/2	5/8	3 1/8	10	11 1/2	5 3/16	6 5/16	2 3/4	4 5/8	7 1/2	9 7/16	9/16
32-200-7 1/2HP	1 1/4 x 2 x 7 5/16	2	3 3/4	4 15/16	6 1/2	1 1/16	1 1/4	2 1/2	3 1/2	5 1/2	5/8	3 1/8	11 9/16	13 3/8	6 5/16	7 1/16	2 3/4	4 11/16	7 1/2	9 7/16	9/16
32-200-10HP	1 1/4 x 2 x 7 7/8	2	3 3/4	4 15/16	6 1/2	1 1/16	1 1/4	2 1/2	3 1/2	5 1/2	5/8	3 1/8	11 9/16	13 3/8	6 5/16	7 1/16	2 3/4	4 11/16	7 1/2	9 7/16	9/16
40-125A-5HP	1 1/2 x 2 1/2 x 4 15/16	2 1/2	4 9/16	5 11/16	7 5/16	1 1/16	1 1/2	2 7/8	3 7/8	5 7/8	5/8	3 1/8	8 3/8	9 15/16	4 7/16	5 1/2	2 3/4	4 1/2	6 5/16	8 1/4	9/16
40-125B-5HP	1 1/2 x 2 1/2 x 5 1/2	2 1/2	4 9/16	5 11/16	7 5/16	1 1/16	1 1/2	2 7/8	3 7/8	5 7/8	5/8	3 1/8	8 3/8	9 15/16	4 7/16	5 1/2	2 3/4	4 1/2	6 5/16	8 1/4	9/16
40-160-7 1/2HP	1 1/2 x 2 1/2 x 5 15/16	2 1/2	4 9/16	5 11/16	7 5/16	1 1/16	1 1/2	2 7/8	3 7/8	5 7/8	5/8	3 1/8	10	11 1/2	5 3/16	6 5/16	2 3/4	4 5/8	7 1/2	9 7/16	9/16
40-160-1-10HP	1 1/2 x 2 1/2 x 6 9/16	2 1/2	4 9/16	5 11/16	7 5/16	1 1/16	1 1/2	2 7/8	3 7/8	5 7/8	5/8	3 1/8	10	11 1/2	5 3/16	6 5/16	2 3/4	4 5/8	7 1/2	9 7/16	9/16
40-200A-15HP	1 1/2 x 2 1/2 x 7 3/16	2 1/2	4 9/16	5 11/16	7 5/16	1 1/16	1 1/2	2 7/8	3 7/8	5 7/8	5/8	3 15/16	11 9/16	13 3/8	6 5/16	7 1/16	2 3/4	4 1/2	8 3/8	10 1/16	9/16
40-200B-15HP	1 1/2 x 2 1/2 x 7 7/8	2 1/2	4 9/16	5 11/16	7 5/16	1 1/16	1 1/2	2 7/8	3 7/8	5 7/8	5/8	3 15/16	11 9/16	13 3/8	6 5/16	7 1/16	2 3/4	4 1/2	8 3/8	10 1/16	9/16
50-125-7 1/2HP	2 x 2 1/2 x 5 3/16	2 1/2	4 9/16	5 11/16	7 5/16	1 1/16	2	3 3/4	4 15/16	6 1/2	11/16	3 15/16	10	11 1/2	5 3/16	6 5/16	2 3/4	4 1/2	7 1/2	9 7/16	9/16
50-125-10HP	2 x 2 1/2 x 5 1/2	2 1/2	4 9/16	5 11/16	7 5/16	1 1/16	2	3 3/4	4 15/16	6 1/2	11/16	3 15/16	10	11 1/2	5 3/16	6 5/16	2 3/4	4 1/2	7 1/2	9 7/16	9/16
50-160-10HP	2 x 2 1/2 x 6 3/16	2 1/2	4 9/16	5 11/16	7 5/16	1 1/16	2	3 3/4	4 15/16	6 1/2	11/16	3 15/16	11 11/16	13 3/8	6 5/16	7 1/16	2 3/4	4 1/2	8 3/8	10 1/16	9/16
50-160-1-15HP	2 x 2 1/2 x 6 9/16	2 1/2	4 9/16	5 11/16	7 5/16	1 1/16	2	3 3/4	4 15/16	6 1/2	11/16	3 15/16	11 11/16	13 3/8	6 5/16	7 1/16	2 3/4	4 1/2	8 3/8	10 1/16	9/16

Unit: inch

Model	JM Frame	Motor									
		b	e	f	g	l ₁	l ₂	l ₃	P	S ₃	F
32-125	145JM	5	15/16	3 ¹ / ₂	5 ¹⁵ / ₁₆	5 ¹ / ₂	6 ¹ / ₂	1	6 ⁹ / ₁₆	11/32	18 ¹⁵ / ₁₆
	182JM	4 ¹ / ₂	-1/16	4 ¹ / ₂	6 ¹ / ₂	7 ¹ / ₂	8 ¹ / ₂	1	7 ³ / ₁₆	13/32	19 ³ / ₁₆
32-160 ^{A/B}	182JM	4 ¹ / ₂	11/16	4 ¹ / ₂	6 ¹ / ₂	7 ¹ / ₂	8 ¹ / ₂	1	7 ³ / ₁₆	13/32	19 ³ / ₁₆
	184JM	5 ¹ / ₂	11/16	4 ¹ / ₂	6 ¹ / ₂	7 ¹ / ₂	8 ¹ / ₂	1	7 ³ / ₁₆	13/32	20 ⁵ / ₈
32-200	184JM	5 ¹ / ₂	1 ³ / ₁₆	4 ¹ / ₂	6 ¹ / ₂	7 ¹ / ₂	8 ¹ / ₂	1	7 ³ / ₁₆	13/32	22 ¹ / ₈
	213JM	5 ¹ / ₂	1 ¹ / ₁₆	5 ¹ / ₄	8	8 ¹ / ₂	9 ¹ / ₂	1	8 ³ / ₁₆	13/32	20 ³ / ₄
	215JM	7	1 ¹ / ₁₆	5 ¹ / ₄	8	8 ¹ / ₂	9 ¹ / ₂	1	8 ³ / ₁₆	13/32	21 ⁷ / ₈
40-125 ^{A/B}	182JM	4 ¹ / ₂	-1/16	4 ¹ / ₂	6 ¹ / ₂	7 ¹ / ₂	8 ¹ / ₂	1	7 ³ / ₁₆	13/32	19 ³ / ₁₆
	184JM	5 ¹ / ₂	-1/16	4 ¹ / ₂	6 ¹ / ₂	7 ¹ / ₂	8 ¹ / ₂	1	7 ³ / ₁₆	13/32	20 ³ / ₄
40-160	184JM	5 ¹ / ₂	11/16	4 ¹ / ₂	6 ¹ / ₂	7 ¹ / ₂	8 ¹ / ₂	1	7 ³ / ₁₆	13/32	22 ¹ / ₈
	213JM	5 ¹ / ₂	-1/16	5 ¹ / ₄	8	8 ¹ / ₂	9 ¹ / ₂	1	8 ³ / ₁₆	13/32	20 ³ / ₄
	215JM	7	-1/16	5 ¹ / ₄	8	8 ¹ / ₂	9 ¹ / ₂	1	8 ³ / ₁₆	13/32	21 ⁷ / ₈
40-200	215JM	7	1 ¹ / ₁₆	5 ¹ / ₄	8	8 ¹ / ₂	9 ¹ / ₂	1	8 ³ / ₁₆	13/32	22 ¹¹ / ₁₆
50-125	184JM	5 ¹ / ₂	11/16	4 ¹ / ₂	6 ¹ / ₂	7 ¹ / ₂	8 ¹ / ₂	1	7 ³ / ₁₆	13/32	22 ¹⁵ / ₁₆
	213JM	5 ¹ / ₂	-1/16	5 ¹ / ₄	8	8 ¹ / ₂	9 ¹ / ₂	1	8 ³ / ₁₆	13/32	21 ⁹ / ₁₆
	215JM	7	-1/16	5 ¹ / ₄	8	8 ¹ / ₂	9 ¹ / ₂	1	8 ³ / ₁₆	13/32	22 ¹¹ / ₁₆
50-160	213JM	5 ¹ / ₂	1 ¹ / ₁₆	5 ¹ / ₄	8	8 ¹ / ₂	9 ¹ / ₂	1	8 ³ / ₁₆	13/32	21 ⁹ / ₁₆
	215JM	7	1 ¹ / ₁₆	5 ¹ / ₄	8	8 ¹ / ₂	9 ¹ / ₂	1	8 ³ / ₁₆	13/32	22 ¹¹ / ₁₆

Remarks:

1. "e" dimensions (-) means H₁<f.
In this case, need distance piece under the pump.
2. "F" dimension indicate maximum dimension.



Model 3UB

EBARA Stainless Steel Centrifugal Pumps

Dimensions

3UB Type 1

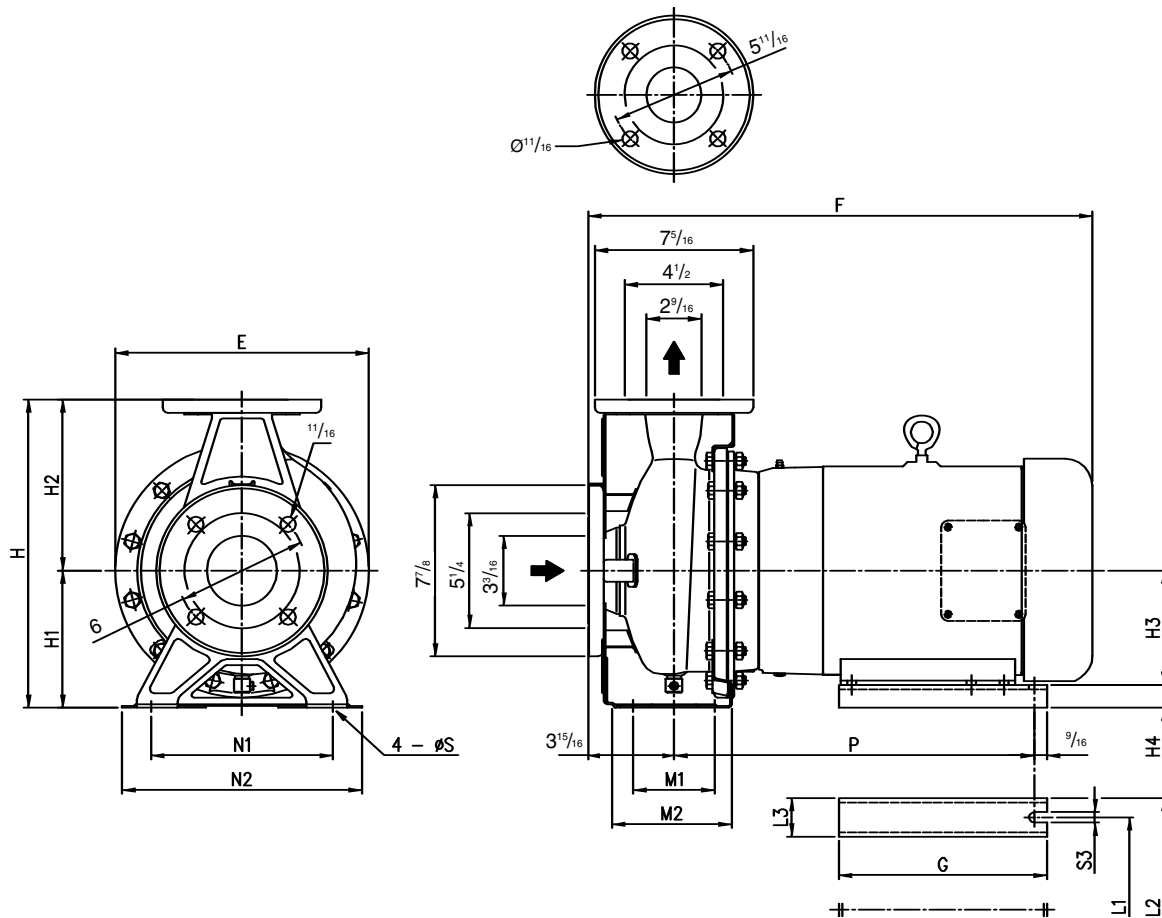

Dimensions: inch

MODEL	SIZE	TYPE	E	F	G	H	H ₁	H ₂	H ₃	H ₄	L ₁	L ₂	L ₃	M ₁	M ₂	N ₁	N ₂	P	S	S ₃
3U 65-125/7.5	2 ¹ / ₂ x 3 x 4 ⁷ / ₈	1	10	23 ³ / ₁₆	9 ⁹ / ₁₆	13 ³ / ₈	6 ⁵ / ₁₆	7 ¹ / ₁₆	5 ¹ / ₄	1 ¹ / ₁₆	8 ¹ / ₂	10 ¹ / ₄	1 ³ / ₄	3 ³ / ₄	5 ¹ / ₂	8 ³ / ₈	11	16 ⁹ / ₁₆	9 ¹ / ₁₆	1 ¹ / ₂
3U 65-125/10	2 ¹ / ₂ x 3 x 5 ⁵ / ₁₆	1	10	23 ³ / ₁₆	9 ⁹ / ₁₆	13 ³ / ₈	6 ⁵ / ₁₆	7 ¹ / ₁₆	5 ¹ / ₄	1 ¹ / ₁₆	8 ¹ / ₂	10 ¹ / ₄	1 ³ / ₄	3 ³ / ₄	5 ¹ / ₂	8 ³ / ₈	11	16 ⁹ / ₁₆	9 ¹ / ₁₆	1 ¹ / ₂
3U 65-160/10	2 ¹ / ₂ x 3 x 5 ³ / ₈	1	11 ⁵ / ₈	23 ³ / ₁₆	9 ⁹ / ₁₆	14 ³ / ₁₆	6 ⁵ / ₁₆	7 ¹ / ₈	5 ¹ / ₄	1 ¹ / ₁₆	8 ¹ / ₂	10 ¹ / ₄	1 ³ / ₄	3 ³ / ₄	5 ¹ / ₂	8 ³ / ₈	11	16 ⁹ / ₁₆	9 ¹ / ₁₆	1 ¹ / ₂
3U 65-160/15	2 ¹ / ₂ x 3 x 5 ⁷ / ₈	1	11 ⁵ / ₈	23 ³ / ₁₆	9 ⁹ / ₁₆	14 ³ / ₁₆	6 ⁵ / ₁₆	7 ¹ / ₈	5 ¹ / ₄	1 ¹ / ₁₆	8 ¹ / ₂	10 ¹ / ₄	1 ³ / ₄	3 ³ / ₄	5 ¹ / ₂	8 ³ / ₈	11	16 ⁹ / ₁₆	9 ¹ / ₁₆	1 ¹ / ₂



Model 3UB

EBARA Stainless Steel Centrifugal Pumps

Dimensions

3UB Type 3

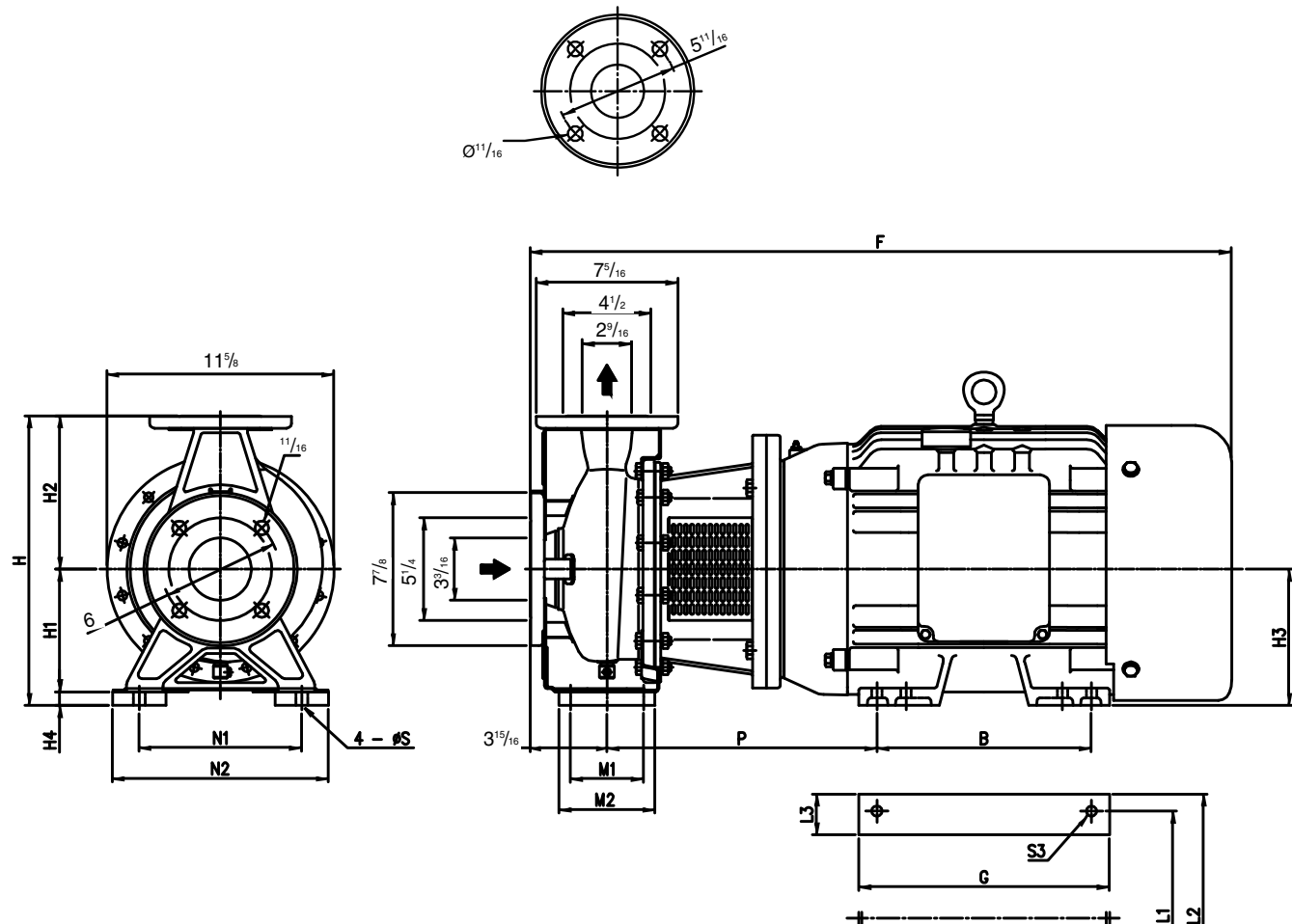

Dimensions: inch

MODEL	SIZE	TYPE	B	F	G	H	H ₁	H ₂	H ₃	H ₄	L ₁	L ₂	L ₃	M ₁	M ₂	N ₁	N ₂	P	S	S ₃
3U 65-160/20	2 1/2 x 3 x 6 5/16	3	10	32 3/8	11 5/8	14 3/16	6 5/16	7 7/8	6 1/4	1/16	10	12 3/8	2 3/8	3 3/4	5 1/2	8 3/8	11	13 13/16	9/16	17/32
3U 65-160/25	2 1/2 x 3 x 6 7/8	3	11	36	12 13/16	14 7/8	6 5/16	7 7/8	7	1 1/16	11	12 3/4	-	3 3/4	4 15/16	8 3/8	11 1/8	13 7/8	9/16	17/32
3U 65-200/20	2 1/2 x 3 x 6 3/4	3	3/4	32 3/8	13 9/16	15 15/16	7 1/16	8 7/8	6 1/4	13/16	10	12 3/8	2 3/8	3 3/4	5 1/2	9 13/16	12 5/8	25 13/16	9/16	9/16
3U 65-200/25	2 1/2 x 3 x 7 1/16	3	11	36	13	15 15/16	7 1/16	8 7/8	7	1/16	11	12 15/16	1 15/16	3 3/4	5 1/2	9 13/16	12 5/8	13 7/8	9/16	17/32
3U 65-200/30	2 1/2 x 3 x 7 1/2	3	11	36	13	15 15/16	7 1/16	8 7/8	7	1/16	11	12 15/16	1 15/16	3 3/4	5 1/2	9 13/16	12 5/8	13 7/8	9/16	17/32

Exploded View

3U

3UB Type 1

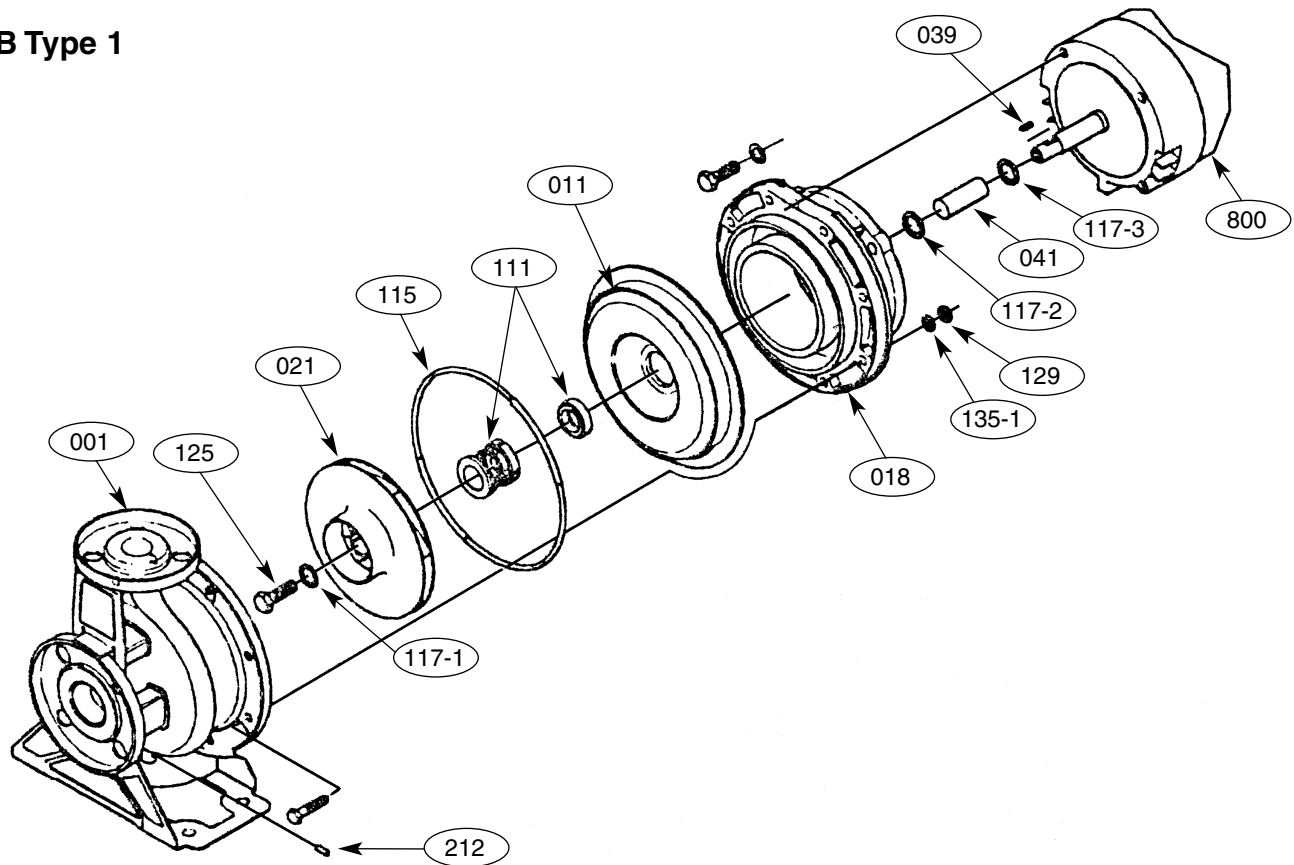

Part No.	Part Name	Material	No. for 1 Unit
001	Casing	304L Stainless	1
011	Casing cover	304L Stainless	1
018	Bracket	Cast Iron	1
021	Impeller (3U)	304L Stainless	1
021	Impeller (3UB)	Bronze	1
039	Key	304L Stainless	1
041	Shaft sleeve	304L Stainless	1
111	Mechanical seal	-	1
115	O-Ring	Viton	1
117-1	Gasket	Nylon	1
117-2	Gasket	Nylon	1
117-3	Gasket	Nylon	1
125	Impeller Bolt	304L Stainless	1
160	Motor support (not shown)	Steel	1 set
212	Plug	304L Stainless	1
800	Motor	-	1
	Suction Flange Gasket	Viton	1
	Discharge Flange Gasket	Viton	1



Model 3UB

EBARA Stainless Steel Centrifugal Pumps

Exploded view

Model 3U 65 Type 3

3U 65-160/20

3U 65-160/25

3U 65-200/20

3U 65-200/25

3U 65-200/30

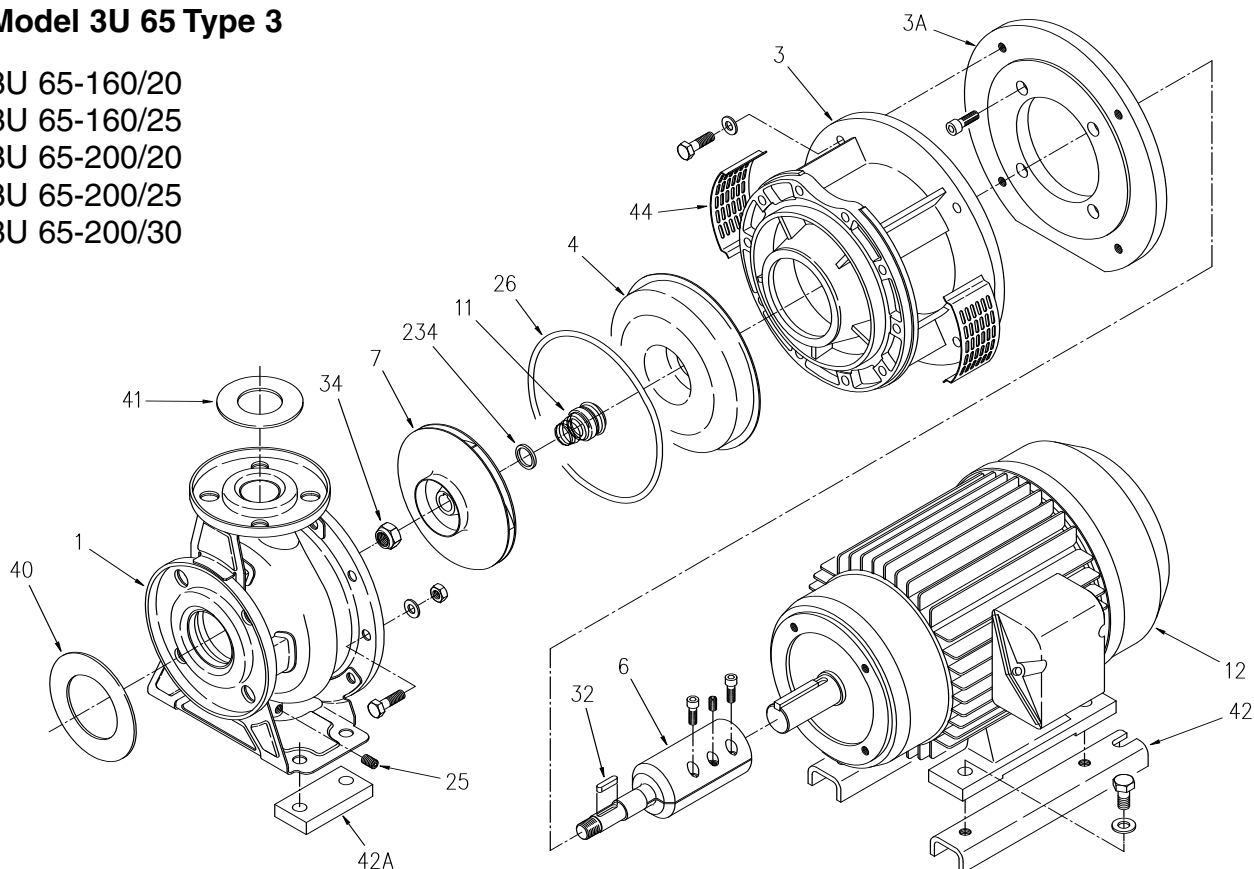

Part No.	Part Name	Material	No. for 1 Unit
001	Casing	304L Stainless	1
003	Motor bracket	Cast iron	1
003A	Adapter ring	Cast iron	1
004	Casing cover	304L Stainless	1
006	Coupling	Steel / Stainless steel	1
007	Impeller	Bronze	1
011	Mechanical seal		1
012	Motor		1
025	Drain plug	304L Stainless	1
026	O-ring	Viton	1
032	Key	304L Stainless	1
034	Impeller nut	Stainless / Nylon	1
040	Flange Gasket	EPDM	2
041	Flange Gasket	EPDM	2
042	Motor support	Steel	2
042A	Casing support (65-160 25HP only)	Steel	2
044	Coupling guard	Stainless Steel	2
234	Lip seal	304L Stainless	1

